



**Alps Produkte
vertrieben durch
Orthoservice Ro+Ten**

**Alps produits
distribu   par
Orthoservice Ro+Ten**

**Prodotti Alps
distribuiti da
Orthoservice Ro+Ten**



**ORTHOERVICE
RO+TEN**

Take care feel better



Wenn das Zusammentreffen ein erfreuliches und glückliches Ereignis war, so ist das Gründen und Leiten einer Gruppe ein Konzept, das wir jeden Tag mit Vertrauen, Ausdauer und Kompetenz voranbringen.

Si se rencontrer a été un heureux et chanceux événement, fonder un groupe et le gérer est une volonté que nous entretenons chaque jour avec confiance, persévérance et compétence.

Se incontrarsi è stato un evento lieto e fortunato, fondare un gruppo e gestirlo è una volontà, che portiamo avanti ogni giorno con fiducia, perseveranza e competenza.

Pamela Pirovano and Paolo Rossi,
founders, Swiss Headquarters Orthoservice Ro+Ten



ORTHOSERVICE RO+TEN:

Wer wir sind · Qui nous sommes · Chi siamo3

Unternehmenskonzept · Système d'entreprise · Sistema azienda4

Inhalt

Inhaltverzeichnis der Bilder6

General Purpose (GPDT | GPFR)8

Extreme Liner (AKDT | AKFR - AKDTHD | AKFRHD)10

EasyLiner (ELDT | ELFR)12

EasyFlex Liner (EZFL)14

EasyLiner SuperStretch (ELPX)16

Superior Performance (SPDT HD | SPFR HD)18

ÖKO liner (ECDTHD | ECFRHD)20

Silicone Pro (LSL | LSC)22

Flex Sleeve (SFX)24

EasySleeve (SFR)26

Prothesenstrümpfe (KCN | KCM | KCW)28

Vacuum Integrated Pump (VIP)30

Sommaire

Index avec images32

General Purpose (GPDT | GPFR)34

Extreme Liner (AKDT | AKFR - AKDTHD | AKFRHD)36

EasyLiner (ELDT | ELFR)38

EasyFlex Liner (EZFL)40

EasyLiner SuperStretch (ELPX)42

Superior Performance (SPDT HD | SPFR HD)44

Eco Liner (ECDTHD | ECFRHD)46

Silicone Pro liner (LSL | LSC)48

Flex Sleeve (SFX)50

EasySleeve (SFR)52

Couvre-moignon (KCN | KCM | KCW)54

Vacuum Integrated Pump (VIP)56

Contenuto

Indice figurato58

General Purpose (GPDT | GPFR)60

Extreme Liner (AKDT | AKFR - AKDTHD | AKFRHD)62

EasyLiner (ELDT | ELFR)64

EasyFlex Liner (EZFL)66

EasyLiner SuperStretch (ELPX)68

Superior Performance Liner (SPDT HD | SPFR HD)70

Eco Liner (ECDTHD | ECFRHD)72

Silicone Pro (LSL | LSC)74

Flex Sleeve (SFX)76

EasySleeve (SFR)78

Compensatori di volume (KCN | KCM | KCW)80

Vacuum Integrated Pump (VIP)82

Orthoservice Ro+Ten: Eine inhabergeführte internationale Firmengruppe

Seit 1978 entwickeln, produzieren und vertreiben wir ein komplettes Sortiment an Orthesen, Einlagen und Bandagen. Ein überzeugendes Preis-Leistungsverhältnis sowie eine hohe Flexibilität in der Produktion und beim gesamten Management haben uns zu einer führenden internationalen Firmengruppe gemacht, die aus dem Herzen Europas agiert.



Orthoservice Ro+Ten: un groupe international au cœur familial

Depuis 1978, nous concevons, fabriquons et distribuons une gamme complète d'orthèses, de semelles orthopédiques et de produits à élasto-compression. Le rapport qualité-prix des produits, ainsi que la flexibilité de la production et de la gestion, nous ont permis de devenir un groupe international leader dans ce secteur, mais dans le cœur, nous avons su rester une famille.

Orthoservice Ro+Ten: un gruppo internazionale con un cuore familiare

Dal 1978 progettiamo, produciamo e distribuiamo una gamma completa di ortesi, plantari e prodotti per l'elastocompressione. Il binomio qualità e prezzo dei prodotti, la flessibilità produttiva e di gestione ci hanno reso un gruppo internazionale leader di settore, ma nel cuore siamo una famiglia.



Ein einzigartiges Unternehmen
mit zahlreichen Produktions- und
Verwaltungsstätten.

Un système d'entreprise unique, de
nombreuses unités de production
et de gestion

Un unico sistema azienda, tante
unità produttive e gestionali

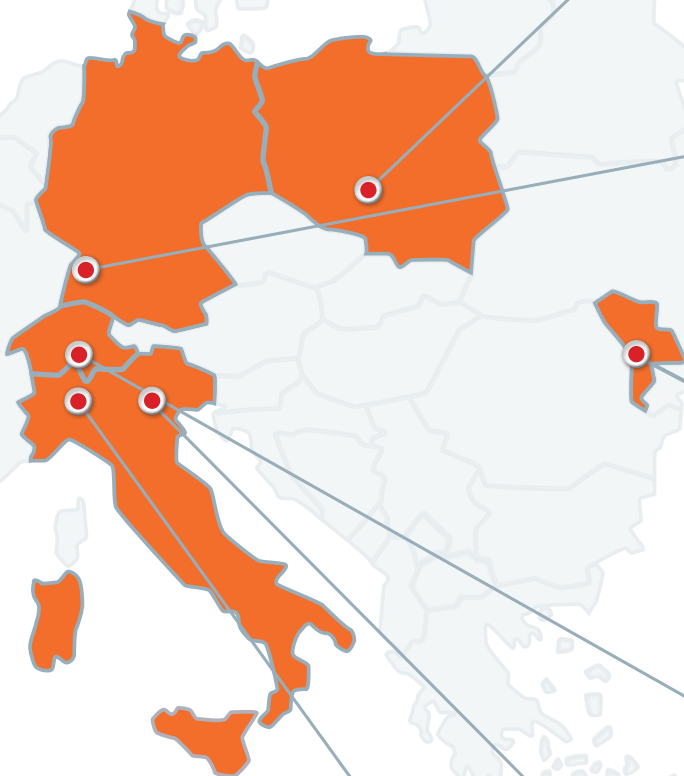

ORTHOERVICE POLSKA Sp. z o.o.
2021 - Częstochowa, Poland



ORTHOERVICE DEUTSCHLAND GmbH
2011 - Baden-Baden, Germany



ICS ORTHOSERVICE
2010 - Balti, Moldova



ORTHOERVICE AG
1996 - Chiasso, Switzerland



ORTOVENETA
2007 - Maser, Italy



RO+TEN S.r.l.
1978 - Verano Brianza, Italy

ORTHOERVICE RO+TEN

- Seit 1978 aktiv im Orthesen-Bereich
Présent depuis 1978 dans le secteur des orthèses
Presente dal 1978 nel settore delle ortesi
- 130 Mitarbeiter in der Orthoservice-Gruppe
Plus de 130 employés
Oltre 130 dipendenti
- 9 angemeldete Patente
9 brevets accrédités
9 brevetti accreditati
- Export in 20 Länder
Exportation vers 20 pays
Esportazione in 20 paesi

Orthoservice Ro+Ten

offizieller Vertriebspartner für **Alps** in der Schweiz

Orthoservice Ro+Ten

distributeur officiel **Alps** en Suisse

Orthoservice Ro+Ten

distributore ufficiale **Alps** in Svizzera

Unsere Philosophie „*Take care feel better*“ trifft auf die von **Alps** „*Making lives better*“. Von unserem Sitz in Chiasso aus vertreiben wir in unserer **Gruppe Orthoservice Ro+Ten** offiziell die Produkte der Marke **Alps in der ganzen Schweiz** mit einem einzigen gemeinsamen Ziel: allen unseren Kunden Produkte von höchster Qualität zur Verfügung zu stellen.

La philosophie du groupe **Orthoservice Ro+Ten** „*Take care feel better*“ rencontre celle d'**Alps** „*Making lives better*“. Depuis son siège de Chiasso, le groupe **Orthoservice Ro+Ten** assure la distribution officielle des produits de la marque **Alps dans toute la Suisse**, avec un seul objectif: fournir à tous nos clients des produits de qualité supérieure.

La filosofia del gruppo **Orthoservice Ro+Ten** „*Take care feel better*“ incontra quella di **Alps** „*Making lives better*“. Dal quartier generale di Chiasso il gruppo **Orthoservice Ro+Ten** esegue la distribuzione ufficiale dei prodotti a marchio **Alps in tutta la Svizzera** con un unico obiettivo: fornire a tutti i nostri clienti prodotti di qualità superiore.

Wer ist Alps

Mit ihrem Hauptsitz in St. Petersburg (Florida) und über 130 Angestellten in 5 Ländern arbeitet **ALPS South LLC** eng mit der medizinischen Gesellschaft zusammen, um verschiedene Medizingeräte zu entwickeln und herzustellen. Im Jahr 1988 gegründet **ALPS** besitzt mehr als 50 Patente in verschiedenen Produktgruppen.

Qui est Alps





































Basée à Saint-Pétersbourg, en Floride, et comptant plus de 130 employés dans 5 pays, **ALPS South LLC** travaille étroitement avec la communauté médicale pour inventer et fabriquer divers dispositifs médicaux. Fondée en 1988, **ALPS** détient plus de 50 brevets dans diverses catégories de produits.

Chi è Alps

Con sede a St. Petersburg, Florida ed oltre 130 impiegati in 5 Paesi, **ALPS South LLC** lavora a stretto contatto con la comunità medica per inventare e produrre diversi dispositivi medici. Fondata nel 1988 **ALPS** possiede più di 50 brevetti in svariate categorie di prodotti.

6 PRODUKTE



PRODUKTE						
Bild	Name	Artikelnr.	Art	Material	Wandstärke	Besonderheiten
	General Purpose Liner	GPDT GPFR	 	 GripGel	Uniform 3 oder 6 mm	Für Patienten mit niedriger Aktivitätsstufe und gesunder Haut
	Extreme Liner	AKDT AKFR AKDTHD AKFRH	 	 HD Gel  GripGel	Uniform 3 oder 6 mm	Empfohlen für OSund aktive US-Amputierte
	Easy Liner	ELDT ELFR	 	 EasyGel	Uniform 3 oder 6mm; Distal- proximal auslaufend 6/3 mm	Für Patienten mit empfindlicher Haut
	Easy Flex Liner	EZF		 EasyGel	Uniform 3 oder 6 mm	Das Produkt eignet sich aufgrund der im Gel enthaltenen Antioxidationsmittel für empfindliche Haut und Diabetes-Patienten
	Easy Liner Super Stretch	ELPX		 EasyGel	Uniform 6 mm	Das Produkt eignet sich aufgrund der im Gel enthaltenen Antioxidationsmittel für empfindliche Haut und Diabetes-Patienten
	Superior Performance Liner	SPDT SPFR SPDTHD SPFRHD	 	 HD Gel  GripGel	Uniform 3 oder 6 mm	Das schwarze Gewebe sorgt für Kontrolle und Stabilität. Ideal für aktive Patienten
	ÖKO Liner	ECDTHD ECFRHD	 	 HD Gel	Uniform 3 oder 6 mm	Distale Konstruktion mit reduzierter Dehnung zur Kontrolle der distalen Distraction
	Silicone PRO	LSC LSL	 	 Silicone	Uniform 3 mm	Hautfreundliches, mit Strickgewebe geschütztes Silikon, für den besten Komfort und Haltbarkeit
	Flex Sleeve	SFX		 HD Gel	Uniform 3 mm	30° Vorflex
	Easy Sleeve	SFR		 EasyGel	Uniform 3 oder 6 mm	Für empfindliche Haut

GENERAL PURPOSE

GPDT | GPFR

Verstärkter Gelliner,
mit oder ohne distalen Anschluss



BESCHREIBUNG

Der General Purpose Gel Liner wurde für Amputierte mit niedrigem Mobilitätsgrad entwickelt. Er ist in ALPS™ GripGel erhältlich, um Komfort, Festigkeit und Elastizität zu bieten. Die sehr gute Dehnbarkeit schränkt die Blutzirkulation nicht ein und erleichtert dem Patienten das An- und Ausziehen.

WICHTIGSTE EIGENSCHAFTEN & VORTEILE

✓ Hochwertiges Gewebe für eine längere Lebensdauer

 **BEIGES GEWEBE**
HORIZONTALE UND
VERTIKALER DEHNUNG

 **MIT
ANSCHLUSS**

✓ Die leichte Haftung verringert die Faltenbildung im Bereich der Kniekehle

 **GRIPGEL**

 **OHNE
ANSCHLUSS**

✓ In 3mm und 6mm uniform erhältlich

QUERSCHNITT

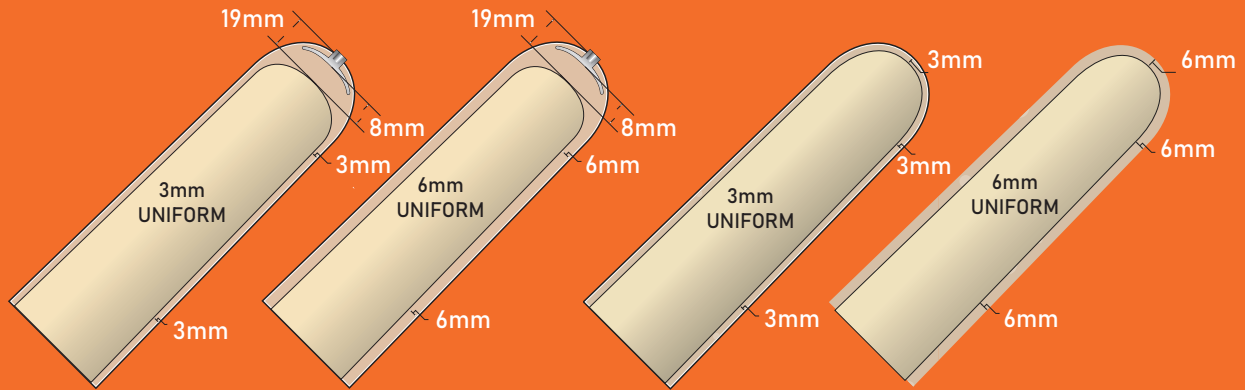

GRÖßENBESTIMMUNG

Umfang 6 cm oberhalb des Stumpfendes messen

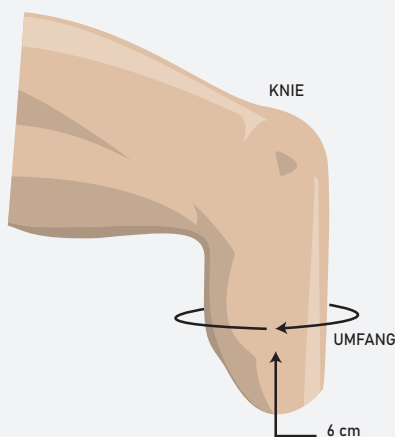

GRÖßENTABELLE

UMFANG (CM)	U MIT ANSCHLUSS 3.0MM oder 6MM UNIFORM	U OHNE ANSCHLUSS 3.0MM oder 6MM UNIFORM
16-19 cm	GPDT 16 - (3 oder 6)	GPFR 16 - (3 oder 6)
20-23 cm	GPDT 20 - (3 oder 6)	GPFR 20 - (3 oder 6)
24-25 cm	GPDT 24 - (3 oder 6)	GPFR 24 - (3 oder 6)
26-27 cm	GPDT 26 - (3 oder 6)	GPFR 26 - (3 oder 6)
28-31 cm	GPDT 28 - (3 oder 6)	GPFR 28 - (3 oder 6)
32-37 cm	GPDT 32 - (3 oder 6)	GPFR 32 - (3 oder 6)
38-43 cm	GPDT 38 - (3 oder 6)	GPFR 38 - (3 oder 6)
44-53 cm	GPDT 44 - (3 oder 6)	GPFR 44 - (3 oder 6)

EXTREME LINER

AKDT | AKFR
AKDTHD | AKFRHD

Für Oberschenkel- und aktive
Unterschenkelamputierte – mit
oder ohne distalen Anschluss



BESCHREIBUNG

Der ALPS™ Extreme Liner wurde extra für Oberschenkel- und aktive Unterschenkelamputierte entwickelt. Er ist mit High Density Gel (HD) oder mit Grip Gel erhältlich, um die Bedürfnisse der meisten Patienten zu befriedigen. Der ALPS Extreme Liner zeichnet sich durch 80% weniger Längsdehnung als andere Gel-Liner aus: Dadurch werden mehr Kontrolle und Stabilität erreicht.

WICHTIGSTE EIGENSCHAFTEN & VORTEILE

- ✓ Das braune Gewebe zeichnet sich durch geringere vertikale Dehnung aus, wodurch der Stumpf geschont wird
- ✓ Die leichte Haftung verringert die Faltenbildung im Bereich der Kniekehle
- ✓ Die Größe des distalen Endes verhält sich proportional zur Linergröße, um das Anziehen zu erleichtern
- ✓ In 3mm oder 6mm uniform erhältlich

OHNE
ANSCHLUSS

MIT
ANSCHLUSS

GRIPGEL

HIGH DENSITY
(HD) GEL

QUERSCHNITT

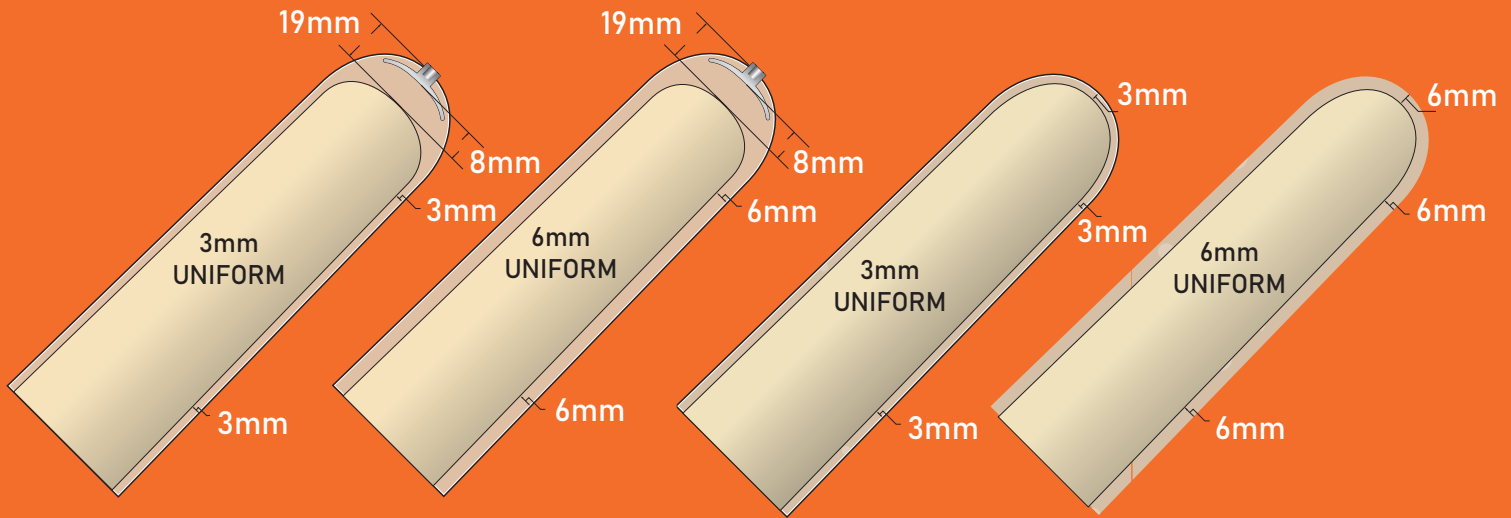

GRÖßENBESTIMMUNG

Umfang 6 cm oberhalb
des Stumpfendes messen

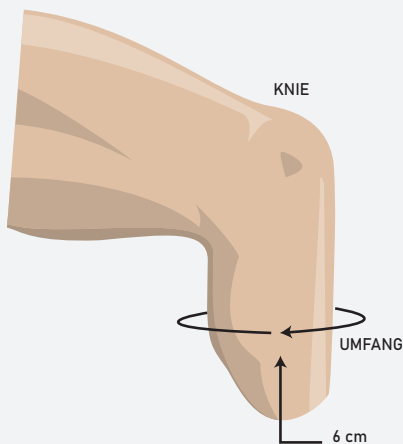

GRÖßENTABELLE

UMFANG (CM)	MIT ANSCHLUSS 3.0MM oder 6MM UNIFORM	OHNE ANSCHLUSS 3.0MM oder 6MM UNIFORM
16-19 cm	AKDT(HD) 16 - (3 oder 6)	AKFR(HD) 16 - (3 oder 6)
20-23 cm	AKDT(HD) 20 - (3 oder 6)	AKFR(HD) 20 - (3 oder 6)
24-25 cm	AKDT(HD) 24 - (3 oder 6)	AKFR(HD) 24 - (3 oder 6)
26-27 cm	AKDT(HD) 26 - (3 oder 6)	AKFR(HD) 26 - (3 oder 6)
28-31 cm	AKDT(HD) 28 - (3 oder 6)	AKFR(HD) 28 - (3 oder 6)
32-37 cm	AKDT(HD) 32 - (3 oder 6)	AKFR(HD) 32 - (3 oder 6)
38-43 cm	AKDT(HD) 38 - (3 oder 6)	AKFR(HD) 38 - (3 oder 6)
44-53 cm	AKDT(HD) 44 - (3 oder 6)	AKFR(HD) 44 - (3 oder 6)

EASYLINER

ELDT | ELFR

Verstärkter Gelliner,
mit oder ohne distalen Anschluss



BESCHREIBUNG

ALPS™ EasyLiner wird mit EasyGel hergestellt, das leistungsstarke Antioxidantien enthält, die sich als äußerst vorteilhaft für die Haut des Stumpfes bewährt haben.

Durch das EasyGel und das Hochleistungsgewebe bietet der EasyLiner eine perfekte Kombination aus Weichheit, Festigkeit, Elastizität, Komfort und Haltbarkeit.

Belege für diese Vorteile finden Sie in den Fallstudien im Produktkatalog.

WICHTIGSTE EIGENSCHAFTEN & VORTEILE



BEIGES GEWEBE
HORIZONTALE UND
VERTIKALER DEHNUNG



EASYGEL



**MIT
ANSCHLUSS**



**OHNE
ANSCHLUSS**

- ✓ Verstärkte Nähte verbessern Haltbarkeit und Aussehen
- ✓ Leistungsfähiges Gewebe zur Verbesserung der Haltbarkeit
- ✓ Flache Verkapselung bietet zusätzlichen Komfort
- ✓ Erhältlich in 3 mm und 6 mm uniform und mit einer auslaufenden Wandstärke von 6 mm distal bis 3 mm proximal

QUERSCHNITT

3mm Uniform, 6mm Uniform, 6/3mm auslaufend

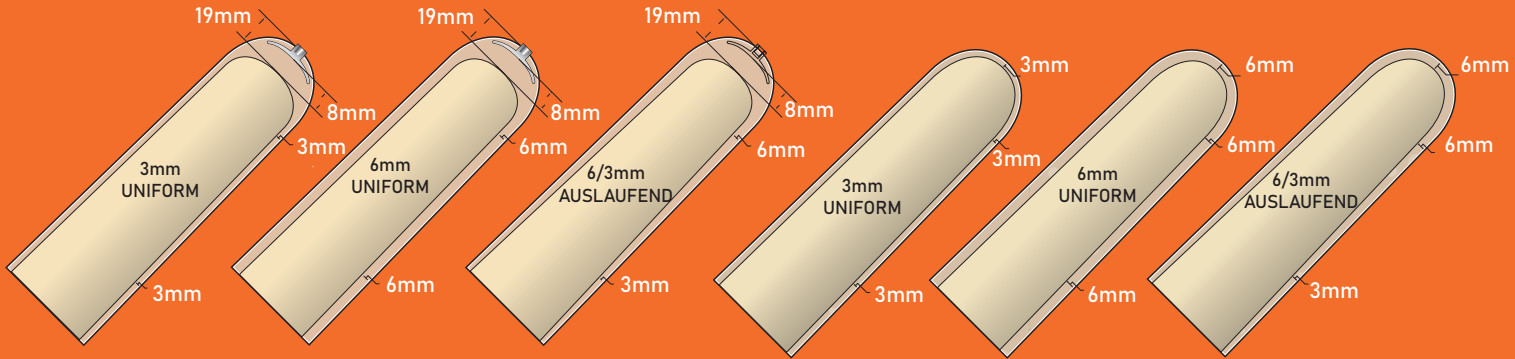

GRÖßENBESTIMMUNG

Umfang 6 cm oberhalb des Stumpfendes messen

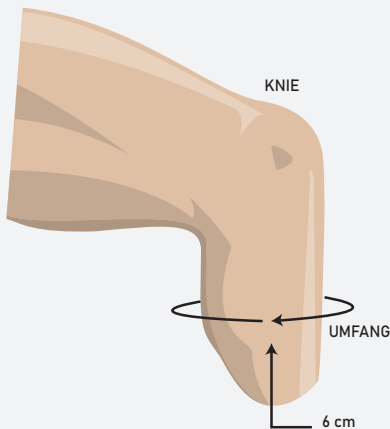

GRÖßENTABELLE

UMFANG (CM)	MIT ANSCHLUSS 3.0MM, 6MM, 6/3MM, ODER 9MM	OHNE ANSCHLUSS 3.0MM, 6MM, 6/3MM, ODER 9MM
16-19 cm	ELDT 16 - (3, 6 oder 6/3)	ELFR 16 - (3, 6 oder 6/3)
20-23 cm	ELDT 20 - (3, 6 oder 6/3)	ELFR 20 - (3, 6 oder 6/3)
24-25 cm	ELDT 24 - (3, 6, 6/3 oder 9)	ELFR 24 - (3, 6, 6/3 oder 9)
26-27 cm	ELDT 26 - (3, 6 oder 6/3)	ELRF 26 - (3, 6 oder 6/3)
28-31 cm	ELDT 28 - (3, 6, 6/3 oder 9)	ELRF 28 - (3, 6, 6/3 oder 9)
32-37 cm	ELDT 32 - (3, 6 oder 6/3)	ELFR 32 - (3, 6 oder 6/3)
38-43 cm	ELDT 38 - (3, 6 oder 6/3)	ELFR 38 - (3, 6 oder 6/3)
44-53 cm	ELDT 44 - (3, 6 oder 6/3)	ELFR 44 - (3, 6 oder 6/3)

EasyFlex™ Liner

EZF

Der Prothesenliner ALPS® EasyFlex erlaubt dank des vorderen Gewebes eine unbegrenzte Knieflexion. Das hintere, dehnungsresistente Gewebe sorgt für eine bessere Kontrolle der Beinprothese. Der Liner enthält ein über lange Abstände freigesetztes Antioxidationsmittel, das freie Radikale und Hydroxylgruppen wirksam neutralisiert und einen wohltuenden Hauteffekt schenkt. Der EasyFlex Liner ist für einen distalen Anschluss im Zusammenhang mit Lock-Systemen ausgelegt.



Material



EasyGel

Gewebe



Beiges Gewebe



Braunes Gewebe

Mobilitätsgrad



K1 ✓



K2 ✓



K3



K4

Wandstärke



3 mm



6 mm

Wichtigste Vorteile



Das Produkt eignet sich aufgrund der im Gel enthaltenen Antioxidationsmittel für empfindliche Haut und Diabetes-Patienten



Dank des hohen Absorptionsvermögens des EasyGels von Vertikal- und Scherkräften wird der Stumpf geschützt



Durch den niedrigen Haftreibungskoeffizienten wird die Haut darüber hinaus vom Stress durch Scherkräfte entlastet



Ermöglicht die problemlose Knieflexion und sorgt für bessere Kontrolle der Beinprothese, da zwei Gewebearten verschiedener Elastizität zum Einsatz kommen



Inklusive distalem Anschluss für den Einsatz in Lock-Systemen

EasyFlex™ Liner EZF. Größentabelle

Umfang 6 cm oberhalb des Stumpfendes messen

Umfang (cm)	Mit Anschluss 3mm oder 6mm uniform
16-19 cm	EZF16-(3 oder 6)
20-23 cm	EZF20-(3 oder 6)
24-25 cm	EZF24-(3 oder 6)
26-27 cm	EZF26-(3 oder 6)
28-31 cm	EZF28-(3 oder 6)
32-37 cm	EZF32-(3 oder 6)
38-43 cm	EZF38-(3 oder 6)
44-53 cm	EZF44-(3 oder 6)

Querschnitt



EZF

Mit Anschluss

**VERSTÄRKTE
MATRIX**

**Breitere Stumpfende,
die proportional zur
Größe des Liners
sind**

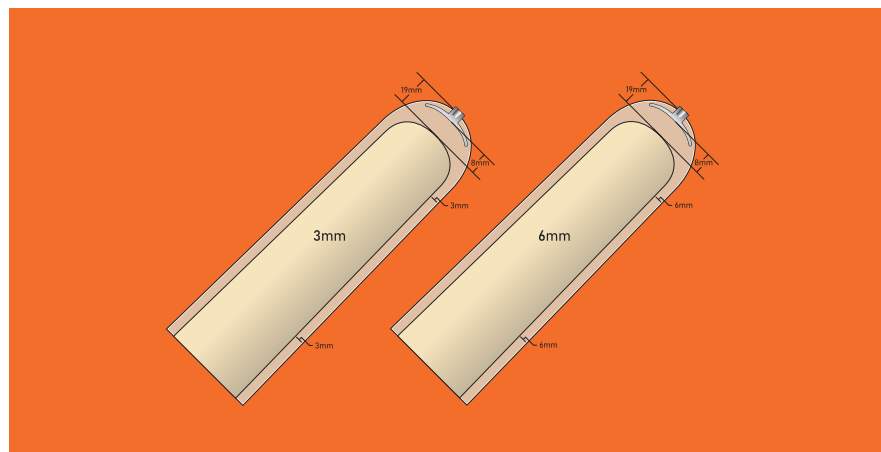

EasyLiner® SuperStretch

ELPX

Der ALPS® EasyLiner® SuperStretch ist ein weicher, robuster und vielseitiger Prothesenliner aus EasyGel, der ohne bewegungseinschränkendes Überzugsgewebe auskommt. Daher ermöglicht er vollständige Bewegungsfreiheit und passt sich auch unregelmäßig geformten Stümpfen an, ohne die Blutzirkulation zu beeinträchtigen. Aufgrund des geringen Reibungskoeffizienten des EasyGel entlastet die Prothese die Haut von Scherkraft-bewirktem Stress. Das über lange Abstände freigesetzte Antioxidationsmittel hat wohltuende Wirkung auf die Haut.



Material



EasyGel

Mobilitätsgrad



K1 ✓

K2 ✓

K3

K4

Wandstärke



6 mm

Wichtigste Vorteile



Das Produkt eignet sich aufgrund der im Gel enthaltenen Antioxidationsmittel für empfindliche Haut und Diabetes-Patienten



Dank des hohen Absorptionsvermögens des EasyGels von Vertikal- und Scherkräften wird der Stumpf geschützt



Durch den niedrigen Haftreibungskoeffizienten wird die Haut darüber hinaus vom Stress durch Scherkräfte entlastet



Der aus EasyGel ohne Überzugsgewebe gefertigte Liner passt sich auch unregelmäßigen Formen hervorragend an, ohne die Bewegungsfreiheit des Stumpfes zu beeinträchtigen

EasyLiner® SuperStretch ELPX. Größentabelle

Umfang 6 cm oberhalb des Stumpfes messen

Umfang (cm)	Ohne Anschluss 6mm uniform
10-15 cm	ELPX-10
16-19 cm	ELPX-16
20-23 cm	ELPX-20
24-25 cm	ELPX-24
26-27 cm	ELPX-26
28-31 cm	ELPX-28
32-37 cm	ELPX-32
38-43 cm	ELPX-38

Querschnitt



ELPX
Ohne Anschluss

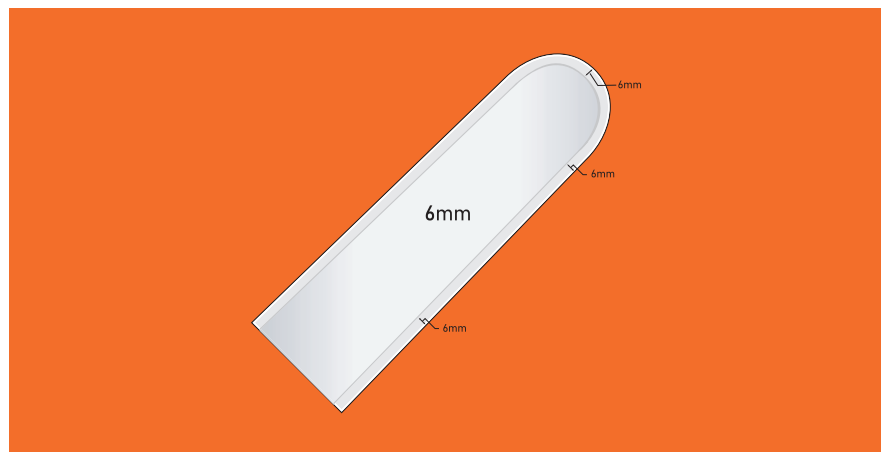

SUPERIOR PERFORMANCE

SPDT (HD) | SPFR (HD)

Verstärkter Gelliner, mit
oder ohne distalen Anschluss



BESCHREIBUNG

Der ALPS™ Superior Performance Liner ist ideal für aktive Patienten und bietet hervorragenden Komfort mit ALPS GripGel oder HD-Gel. Der SP Liner verfügt über ein NEUES schwarzes Gewebe, das zusätzlichen Komfort und bessere Stabilität ermöglicht.

HAUPTMERKMALE

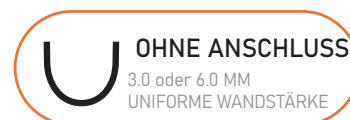

QUERSCHNITT

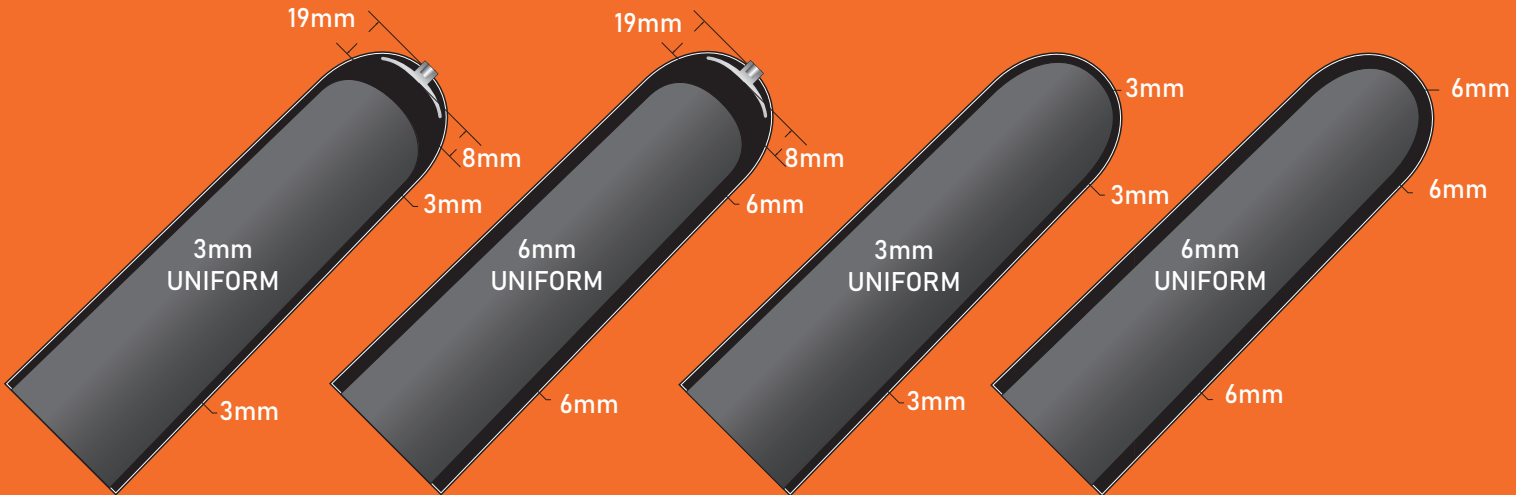

GRÖßENBESTIMMUNG

Umfang 6 cm oberhalb des Stumpfendes messen

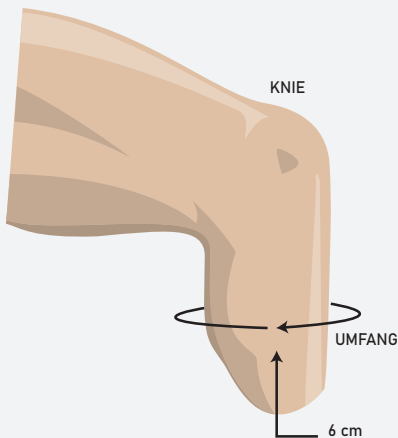

GRÖßENTABELLE

UMFANG (CM)	MIT ANSCHLUSS 3.0MM oder 6MM UNIFORM	OHNE ANSCHLUSS 3.0MM oder 6MM UNIFORM
16-19 cm	SPDT(HD) 16 - (3 oder 6)	SPFR(HD) 16 - (3 oder 6)
20-23 cm	SPDT(HD) 20 - (3 oder 6)	SPFR(HD) 20 - (3 oder 6)
24-25 cm	SPDT(HD) 24 - (3 oder 6)	SPFR(HD) 24 - (3 oder 6)
26-27 cm	SPDT(HD) 26 - (3 oder 6)	SPFR(HD) 26 - (3 oder 6)
28-31 cm	SPDT(HD) 28 - (3 oder 6)	SPFR(HD) 28 - (3 oder 6)
32-37 cm	SPDT(HD) 32 - (3 oder 6)	SPFR(HD) 32 - (3 oder 6)
38-43 cm	SPDT(HD) 38 - (3 oder 6)	SPFR(HD) 38 - (3 oder 6)
44-53 cm	SPDT(HD) 44 - (3 oder 6)	SPFR(HD) 44 - (3 oder 6)

ÖKO LINER

ECDTHD | ECFRHD

Gelliner – mit oder ohne
distalen Anschluss

BESCHREIBUNG

Der ALPS™ ÖKO Liner bietet eine neue distale Konstruktion mit reduzierter Dehnbarkeit zur Kontrolle der distalen Distraction. Der ÖKO Liner wird mit weniger Energieeinsatz hergestellt und erhält durch sein neues, nahtloses Gewebe eine moderne Optik.

Er ist mit oder ohne distalen Anschluss und mit ALPS High Density Gel erhältlich, um aktiven Menschen mit Amputation eine bessere Kontrolle zu ermöglichen.

HAUPTMERKMALE

GERINGE
DEHNBARKEIT

NEUE DISTALE
KONSTRUKTION



MIT ANSCHLUSS
3.0 oder 6.0 MM UNIFORME
WANDSTÄRKE



HIGH DENSITY
(HD) GEL



OHNE ANSCHLUSS
3.0 oder 6.0 MM UNIFORME
WANDSTÄRKE

HOHE
DEHNBARKEIT

QUERSCHNITT

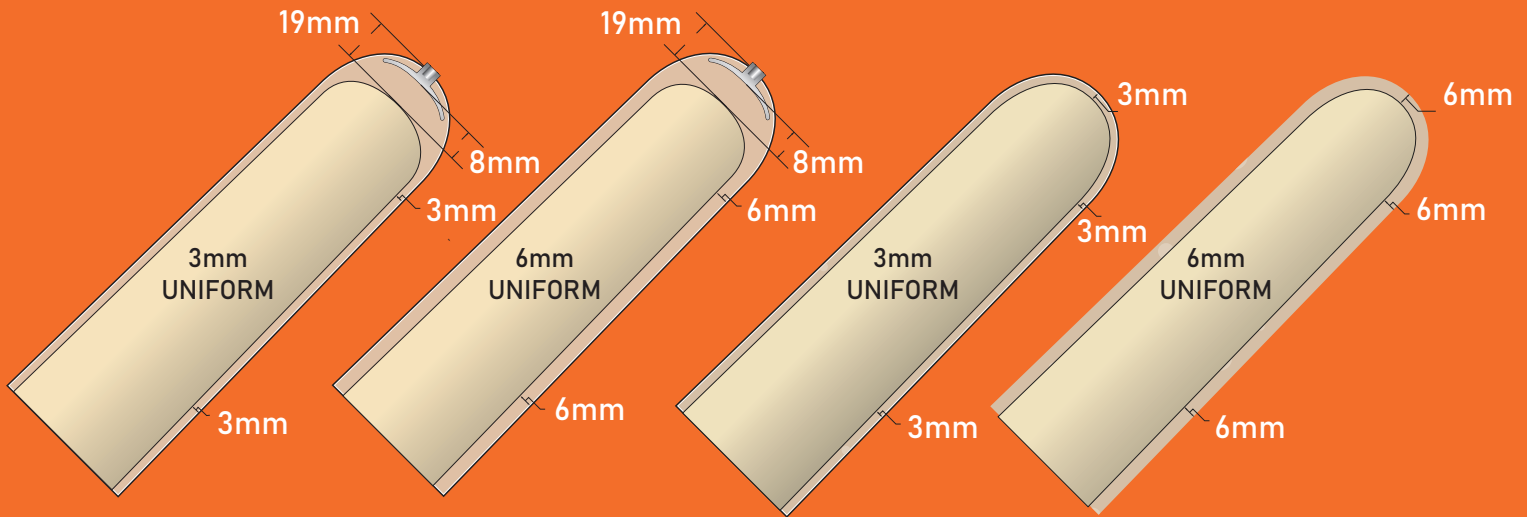

GRÖßENBESTIMMUNG

Umfang 6 cm oberhalb
des Stumpfendes messen

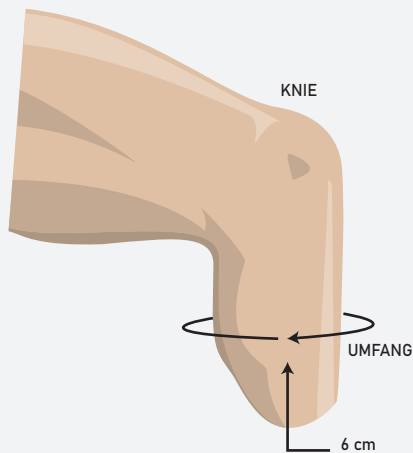

GRÖßENTABELLE

UMFANG (CM)	MIT ANSCHLUSS 3.0MM or 6MM UNIFORM	OHNE ANSCHLUSS 3.0MM or 6MM UNIFORM
20-23 cm	ECDTHD 20 - (3 oder 6)	ECFRHD 20 - (3 oder 6)
24-25 cm	ECDTHD 24 - (3 oder 6)	ECFRHD 24 - (3 oder 6)
26-27 cm	ECDTHD 26 - (3 oder 6)	ECFRHD 26 - (3 oder 6)
28-31 cm	ECDTHD 28 - (3 oder 6)	ECFRHD 28 - (3 oder 6)
32-37 cm	ECDTHD 32 - (3 oder 6)	ECFRHD 32 - (3 oder 6)
38-43 cm	ECDTHD 38 - (3 oder 6)	ECFRHD 38 - (3 oder 6)
44-53 cm	ECDTHD 44 - (3 oder 6)	ECFRHD 44 - (3 oder 6)

SILICONE PRO

LSL / LSC

Silikonliner - mit Gewebe verstärkt

BESCHREIBUNG

ALPS™ Silicone Pro ist ein Prothesenliner aus medizinischem Silikon und ist durch ein gestricktes Gewebe geschützt. ALPS Silicone PRO ist mit oder ohne distalen Anschluss erhältlich und bietet gleichzeitig Komfort und Bewegungsfreiheit.

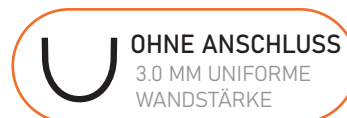
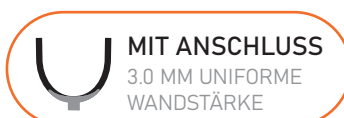

HAUPTMERKMALE

- 1/5 der Reibung von normalem Silikon
- Medizinisches Silikon mit Strickgewebeüberzug
- Leicht
- Reduzierter Längshub
- Hautfreundliches Material und dünnes Profil
- Kühlende Wirkung

REIBUNGSTEST

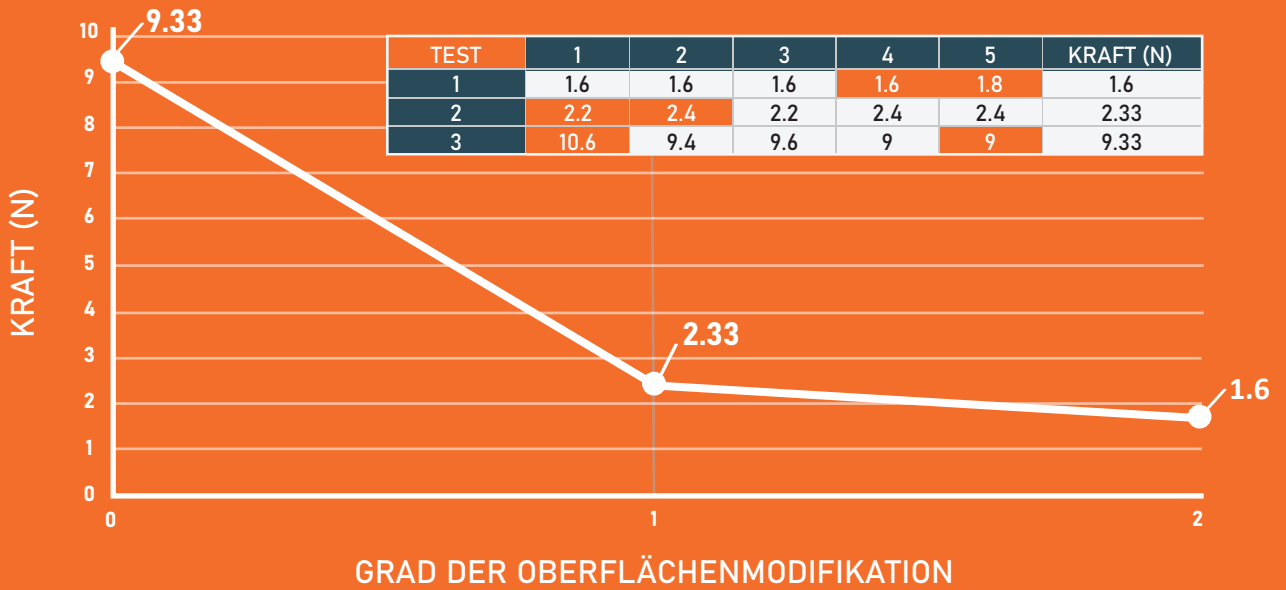

QUERSCHNITT

3.0 mm Uniform

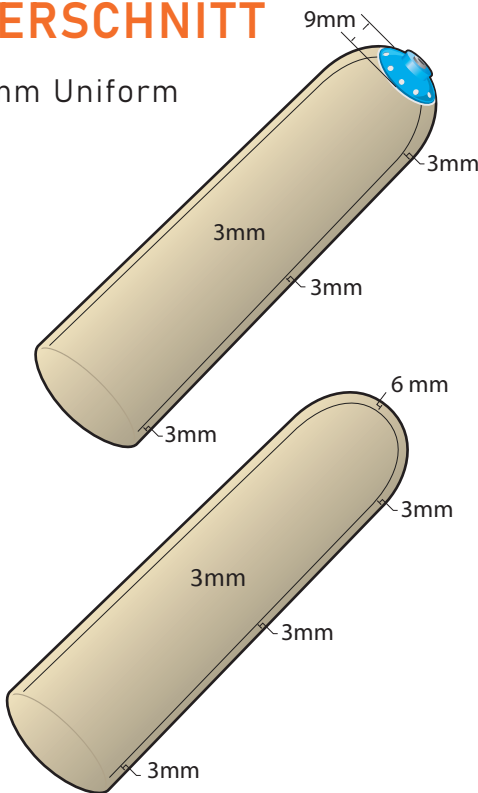

GRÖßENBESTIMMUNG

Umfang 6 cm oberhalb des Stumpfendes messen

GRÖßENTABELLE

UMFANG (CM)	MIT ANSCHLUSS 3.0 MM UNIFORM	OHNE ANSCHLUSS 3.0 MM UNIFORM
20-22 cm	LSL3.0-20	LSC3.0-20
22-24 cm	LSL3.0-22	LSC3.0-22
24-26 cm	LSL3.0-24	LSC3.0-24
26-28 cm	LSL3.0-26	LSC3.0-26
28-30 cm	LSL3.0-28	LSC3.0-28
30-32 cm	LSL3.0-30	LSC3.0-30
32-35 cm	LSL3.0-32	LSC3.0-32
35-38 cm	LSL3.0-35	LSC3.0-35
38-41 cm	LSL3.0-38	LSC3.0-38
41-44 cm	LSL3.0-41	LSC3.0-41
44-47 cm	LSL3.0-44	LSC3.0-44

FLEX

SLEEVE

SFX

Gel-Kniekappe

BESCHREIBUNG

ALPS™ Flex Sleeve (SFX) ist eine prothetische Gel-Kniekappe, die ein nahtloses Strickgewebe mit dem High Density Gel für maximalen Komfort kombiniert. Die SFX Kniekappe hat eine 30° Vorflexion, die eine leichte Kniebeugung ermöglicht und die Faltenbildung im Kniekehlenbereich reduziert.

HAUPTMERKMALE



30° Vorflexion



Das High Density Gel (HD Gel) sorgt für maximale Kontrolle auch bei aktiven Patienten



Eine Länge ist für die meisten Anwender geeignet

NAHTLOSES STRICKGEWEBE

In-house gestricktes Gewebe mit hochwertigen Garnen

2 FARBOPTIONEN



SCHWARZES GEWEBE



BEIGES GEWEBE

QUERSCHNITT



3 MM UNIFORM



3 MM UNIFORM

GRÖßENBESTIMMUNG

Umfang 10 cm oberhalb der Patella messen

GRÖßENBESTIMMUNG

UMFANG (CM)	3.0 MM UNIFORM BEIGES GEWEBE	3.0 MM UNIFORM SCHWARZES GEWEBE
34-37 cm	SFX20 - 3B	SFX20 - 3G
36-39 cm	SFX23 - 3B	SFX23 - 3G
38-42 cm	SFX26 - 3B	SFX26 - 3G
41-46 cm	SFX29 - 3B	SFX29 - 3G
45-50 cm	SFX32 - 3B	SFX32 - 3G

EasySleeve

SFR

ALPS® EasySleeve Reinforced Fabric bietet dank des ALPS® EasyGel ausgezeichneten Komfort. Die Elastizität des Gewebes ermöglicht den Benutzern unbegrenzte Knieflexion. Da die EasySleeve sanft auf der Haut aufliegt, ohne die Blutzirkulation zu beeinträchtigen, garantiert sie einen perfekten Halt. Der mit dem EasyGel einhergehende niedrigere Reibungskoeffizient entlastet die Haut von Scherkräften.



Material



EasyGel

Gewebe



Beiges Gewebe

Mobilitätsgrad



K1 ✓



K2 ✓



K3



K4

Wandstärke



3 mm



6 mm

Wichtigste Vorteile



Auch für Patienten mit eingeschränkter Bewegungsfähigkeit der Hände leicht anzulegen



Das Produkt eignet sich aufgrund der im Gel enthaltenen Antioxidationsmitteln für empfindliche Haut



Verringert proximalen Druck und Hautirritationen



Bietet immer hohe Bewegungsfreiheit für die Knieflexion



Entlastung der Haut von Scherkräften dank des niedrigen Haftreibungskoeffizienten von EasyGel

EasySleeve SFR. Größentabelle

Umfang 10 cm oberhalb der Patella messen

Umfang (cm)	3mm oder 6mm uniform
16-19 cm	SFR10-(3 oder 6)
20-24 cm	SFR16-(3 oder 6)
25-30 cm	SFR20-(3 oder 6)
31-34 cm	SFR24-(3 oder 6)
35-37 cm	SFR26-(3 oder 6)
38-40 cm	SFR28-(3 oder 6)
41-45 cm	SFR32-(3 oder 6)
46-60 cm	SFR38-(3 oder 6)
61-70 cm	SFR44-(3 oder 6)

Querschnitt

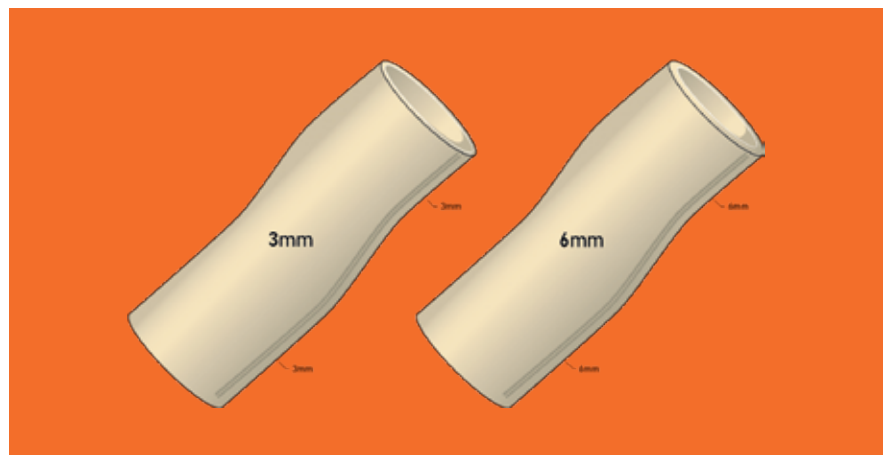

Prothesenstrümpfe zum Volumenausgleich



KCN | KCM | KCW

ALPS® Prothesenstrümpfe sind leicht und weich, sorgen für Dämpfung und bieten Komfort und eine hervorragende Passform.

PRODUKTSPEZIFIKATIONEN



HIGHLIGHTS

- Helfen bei Volumenschwankungen
- Die technischen Fasern ermöglichen ein kühles, angenehmes Tragegefühl
- Behalten die Form im Laufe der Zeit mit einer minimalen Dehnung und verfilzen nicht
- JETZT ALS BUNDLE ERHÄLTlich!** Eine Komplettlösung für Patienten, um die Volumenschwankung ihres Stumpfes zu behandeln. Die gängigsten Wandstärken sind immer zur Hand.



HERGESTELLT MIT PREMIUM TECHNISCHEN FASERN

SCHAFFEN EIN FEUCHTIGKEITSMANAGEMENT-SYSTEM, SO DASS DIE TRANSPIRATION SCHNELL VOM KÖRPER WEG IN DAS GEWEBE GELEITET WIRD UND DORT VERDUNSTEN KANN.

MIT DEM PAKET KÖNNEN IHRE PATIENTEN:

- die Strümpfe auswählen, die sie zur Bewältigung ihrer Schwankungen benötigen
- immer Prothesenstrümpfe zur Hand haben, wenn andere in der Wäsche sind

MAßSKIZZE

Der Prothesenstrumpf sollte ca. 5 cm länger sein als der Schaft

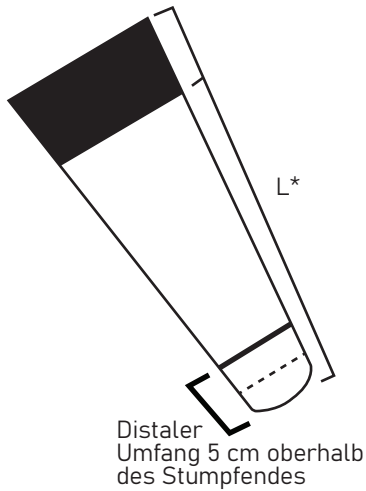

GRÖßENBESTIMMUNG

Umfang 5 cm oberhalb des Stumpfendes messen

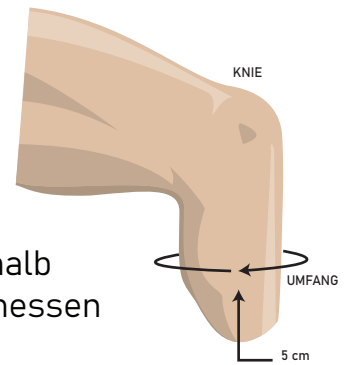

GRÖßENTABELLE

FINDEN SIE DIE PERFEKTE PASSFORM.

EMPFOHLENE ALPS LINERGRÖßE	AMPUTATIONSGRAD	PROXIMALER UMFANG	UMFANG 5 CM OBERHALB DES STUMPFENDES	*LÄNGE DES SCHAFTES 13-18 CM	*LÄNGE DES SCHAFTES 18-23 CM	*LÄNGE DES SCHAFTES 23-38 CM	*LÄNGE DES SCHAFTES 38-48 CM
20	US	min. 20-max. 40 cm	20-23 cm	KCN-8-X-Y	KCN-10-X-Y	KCN-14-X-Y	KCN-18-X-Y
24, 26, 28	US	min. 30-max. 60 cm	23-31 cm	KCM-8-X-Y	KCM-10-X-Y	KCM-14-X-Y	KCM-18-X-Y
32, 38	OS	min. 40-max. 80 cm	31-36 cm	KCW-8-X-Y	KCW-10-X-Y	KCW-14-X-Y	KCW-18-X-Y

X bezeichnet die Wandstärke in Ply (**1Ply= 1,5mm; 3Ply= 2mm; 5Ply=2,5mm**)

Y bezeichnet das distale Ende (N ohne Loch; H mit Loch; HR mit verstärktem Loch)

BEISPIELE:

KCN-08-3-H Prothesenstrumpf, Small, Extra Kurz, 3 Ply, mit Loch

KCM-10-1-N Prothesenstrumpf, Medium, Kurz, 1 Ply, ohne Loch

KCW-18-5-HR Prothesenstrumpf, Groß, Lang, 5 Ply, mit verstärktem Loch

VACUUM INTEGRATED PUMP





VIP



BESCHREIBUNG

ALPS™ VIP ist eine prothetische integrierte Vakuumpumpe für aktiven Unterdruck. Sie garantiert dem Benutzer einen kontinuierlichen totalen Kontakt zwischen Stumpf und Schaft. Dies ist sowohl für eine gleichmäßige Gewichtsverteilung als auch für die Verteilung der Prothesenfederung über die gesamte Oberfläche der Gliedmaße unerlässlich. Das vom VIP erzeugte Vakuum stabilisiert das Stumpfbein und überwindet alle Probleme, die mit dem Volumenwechsel des Stumpfes im Verlauf des Tages verbunden sind.

ZUSÄTZLICHE VORTEILE

-  Verwaltet effizient die Volumenschwankungen des Stumpfes und bietet somit bessere Kontrolle und einen besseren Komfort der Prothese
-  Reduziert die Intensität von Druckspitzen auf die Gliedmaßen des Patienten, verbessert den Komfort und bietet mehr Bewegungsfreiheit
-  Hilft, die Gesundheit der Stumpfhaut zu erhalten, indem die Durchblutung verbessert und folglich die Sauerstoffversorgung der Gliedmaßen erhöht wird
-  Beeinträchtigt nicht die ästhetische Erscheinung der Prothese

Ist einfach zu installieren

Verbessert die Blutzirkulation

Verbessert den Komfort

Verbessert den Bewegungsablauf

Ist leise

Ist leicht

IN 2 UNTERSCHIEDLICHEN VAKUUMSTUFEN ERHÄLTlich

HOHES VAKUUM
(Rot)

10-13 inHg

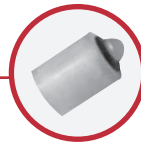

Wir empfehlen dringend, das **Miniventil** zu verwenden, um eine distale Distraction zu vermeiden

NIEDRIGES VAKUUM
(GRÜN)

5-8 inHg



VAKUUMSTUFE
AUSWÄHLEN
JE NACH:

AKTIVITÄTSGRAD

HAUTZUSTAND

OHNE MONTAGEPLATTE



MIT MONTAGEPLATTE



PRODUKTSPEZIFIKATIONEN

	HOHES VAKUUM (ROT)	NIEDRIGES VAKUUM (GRÜN)
ARTIKELNR.	VIP - DH	VIP - DL
DURCHMESSER	66MM	66MM
HÖHE	48MM	48MM
GEWICHT	75G	64G
MATERIAL	SILIKON	SILIKON





































BITTE VERWENDEN SIE BEI DER BESTELLUNG
DIE UNTEN STEHENDE ARTIKELNUMMER

ARTIKEL	ARTIKELNR.
DUMMY	VE319 - D
KURZES DUMMY	VE319 - SD
MONTAGEPLATTE	VE819 - P
LOCK (KLEIN)	VIP-L1120-S
MINIVENTIL (dringend empfohlen)	MV-009
MINIVENTIL-KIT	LMV-009
PIN (4.8cm)	VIP-92L
PIN (3.0cm)	VIP-92S





PRODUITS

PRODUITS						
Image	Nom	Code	Typologie	Matériel	Épaisseur	Caractéristiques
	General Purpose Liner	GPDT GPFR	 	 GripGel	Uniforme 3 o 6 mm	Convient aux faibles niveaux d'activité et à une peau saine
	Extreme Liner	AKDT AKFR AKDTHD AKFRH	 	 HD Gel  GripGel	Uniforme 3 o 6 mm	Recommandé pour amputés transfémoraux et transtibiaux actifs - avec ou sans accrochage distal
	Easy Liner	ELDT ELFR	 	 EasyGel	Uniforme 3 o 6 mm; conique 6mm distale/3 mm proximale	Pour les patients à la peau sensible
	Easy Flex Liner	EZF		 EasyGel	Uniforme 3 o 6 mm	Indiqué pour les utilisateurs diabétiques et ayant la peau sensible, grâce aux antioxydants contenus dans le gel
	Easy Liner Super Stretch	ELPX		 EasyGel	Uniforme 6 mm	Indiqué pour les utilisateurs diabétiques et ayant la peau sensible, grâce aux antioxydants contenus dans le gel
	Superior Performance Liner	SPDT SPFR SPDTHD SPFRHD	 	 HD Gel  GripGel	Uniforme 3 o 6 mm	Doté d'un tissu noir garantissant plus de confort et de stabilité Idéal pour les patients actifs
	ECO Liner	ECDTHD ECFRHD	 	 HD Gel	Uniforme 3 o 6 mm	Sa structure innovante limite l'élasticité au niveau distal
	Silicone PRO	LSC LSL	 	 Silicone	Uniforme 3 mm	Manchon en silicone doux pour la peau, recouvert de tissu pour un confort et une durabilité optimale
	Flex Sleeve	SFX		 HD Gel	Uniforme 3 mm	Genouillère avec pré-flexion de 30°
	Easy Sleeve	SFR		 EasyGel	Uniforme 3 o 6 mm	Indiqué pour les peaux délicates et fragiles

GENERAL PURPOSE

GPDT | GPFR

Manchon gel, renforcé - avec ou sans accrochage distal



DESCRIPTION

Le manchon General Purpose Gel Liner est conçu pour les amputés à activité modérée. Il est disponible en ALPS™ GripGel, offrant confort, résistance et élasticité. L'allongement important de ce manchon évite de restreindre la circulation sanguine dans le membre de l'utilisateur, avec une mise en place et un retrait faciles.

EXCELLENTS AVANTAGES ET CARACTÉRISTIQUES

- ✓ Le tissu hautement performant améliore la durabilité
- ✓ Légèrement adhérent afin de réduire les plis dans la fosse poplitée
- ✓ Disponible en épaisseur uniforme 3 mm et 6 mm

 **TISSU BEIGE**
ÉTIREMENT HORIZONTAL
ET VERTICAL

 **ACCROCHAGE**

 **GRIPGEL**

 **CUSHION**

SCHÉMA COUPE TRANSVERSALE

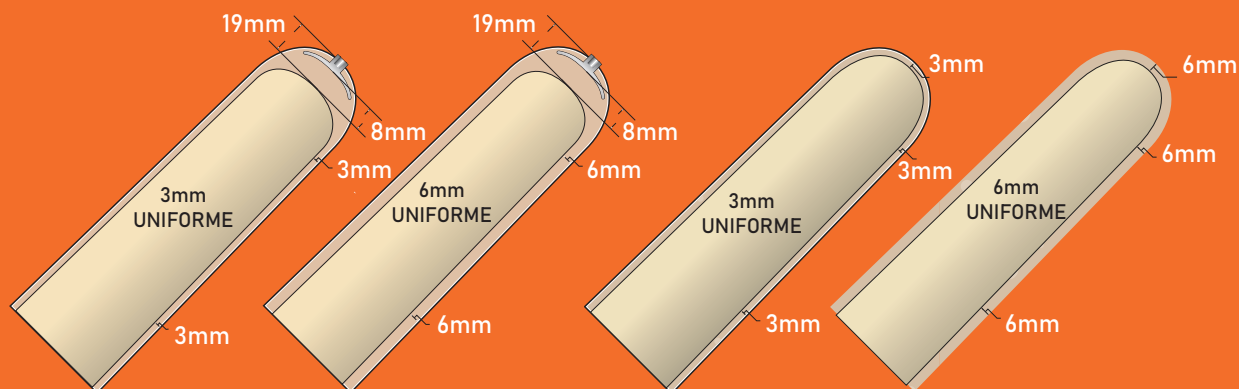

COMMENT MESURER

Mesures prise à 6 cm de l'extrémité distale



TABLEAU DE TAILLES

TAILLE MESURÉE (CM)	ACCROCHAGE ÉPAISSEUR UNIFORME 3 mm ou 6 mm	CUSHION ÉPAISSEUR UNIFORME 3 mm ou 6 mm
16-19 cm	GPDT 16 - (3 ou 6)	GPFR 16 - (3 ou 6)
20-23 cm	GPDT 20 - (3 ou 6)	GPFR 20 - (3 ou 6)
24-25 cm	GPDT 24 - (3 ou 6)	GPFR 24 - (3 ou 6)
26-27 cm	GPDT 26 - (3 ou 6)	GPRF 26 - (3 ou 6)
28-31 cm	GPDT 28 - (3 ou 6)	GPRF 28 - (3 ou 6)
32-37 cm	GPDT 32 - (3 ou 6)	GPFR 32 - (3 ou 6)
38-43 cm	GPDT 38 - (3 ou 6)	GPFR 38 - (3 ou 6)
44-53 cm	GPDT 44 - (3 ou 6)	GPFR 44 - (3 ou 6)

EXTREME LINER

AKDT | AKFR
AKDTHD | AKFRHD

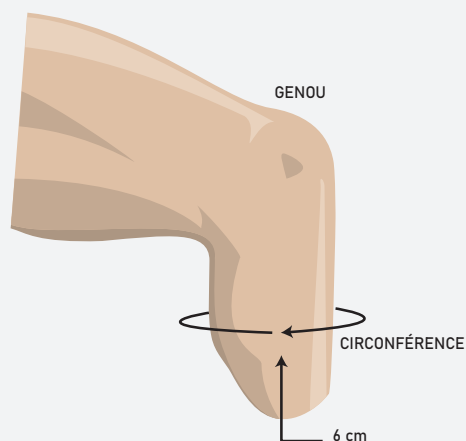
Pour amputés transfémoraux
et transtibiaux actifs - avec
ou sans accrochage distal



DESCRIPTION

Le manchon ALPS™ Extreme Liner est spécialement conçu pour les amputés transfémoraux et transtibiaux actifs. Il est disponible en GripGel ou HD Gel pour offrir un confort maximal. Le manchon Extreme Liner présente un étirement vertical 80 % moindre que les autres manchons gel ALPS, offrant davantage de contrôle et de stabilité.

EXCELLENTS AVANTAGES ET CARACTÉRISTIQUES

- ✓ Le tissu brun offre un étirement vertical limité afin de limiter le mouvement des tissus redondants
- ✓ Extrémité distale la plus large proportionnelle à la taille du manchon pour une mise en place facile
- ✓ Légèrement adhérent afin de réduire les plis dans la fosse poplitée
- ✓ Disponible en épaisseur uniforme 3 mm et 6 mm



CUSHION



ACCROCHAGE



GRIPGEL



HIGH DENSITY
(HD) GEL

SCHÉMA COUPE TRANSVERSALE

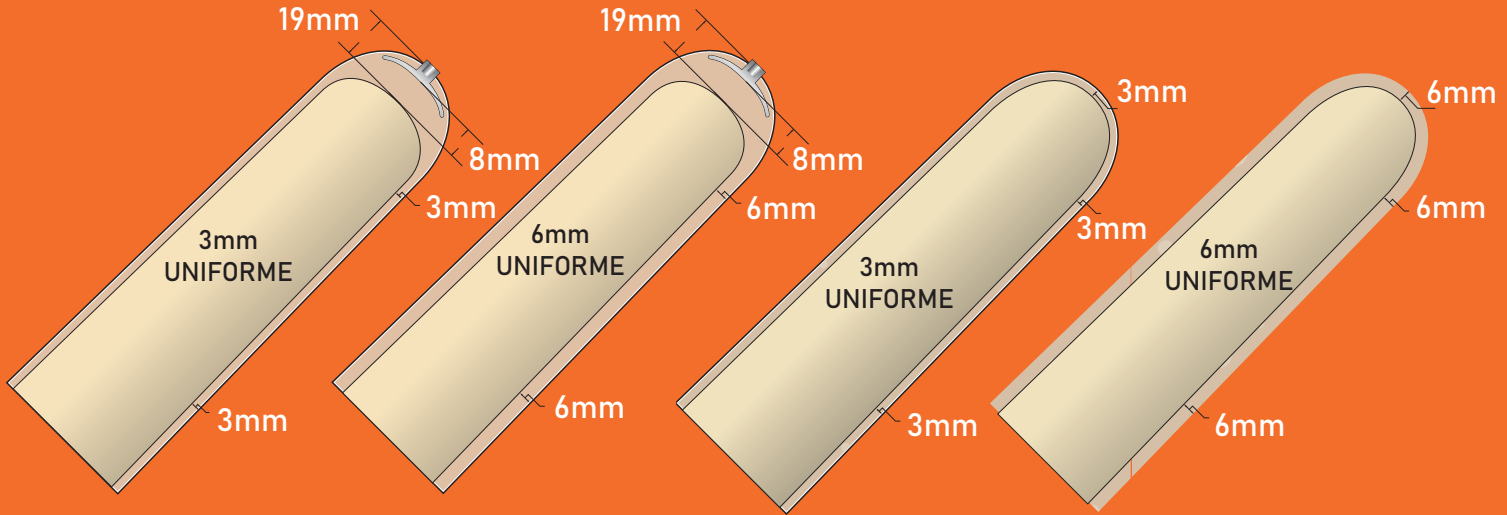

COMMENT MESURER

Mesures prise à 6 cm de l'extrémité distale



TABLEAU DE TAILLES

TAILLE MESURÉE (CM)	ACCROCHAGE ÉPAISSEUR UNIFORME 3 mm ou 6 mm	CUSHION ÉPAISSEUR UNIFORME 3 mm ou 6 mm
16-19 cm	AKDT(HD) 16 - (3 ou 6)	AKFR(HD) 16 - (3 ou 6)
20-23 cm	AKDT(HD) 20 - (3 ou 6)	AKFR(HD) 20 - (3 ou 6)
24-25 cm	AKDT(HD) 24 - (3 ou 6)	AKFR(HD) 24 - (3 ou 6)
26-27 cm	AKDT(HD) 26 - (3 ou 6)	AKFR(HD) 26 - (3 ou 6)
28-31 cm	AKDT(HD) 28 - (3 ou 6)	AKFR(HD) 28 - (3 ou 6)
32-37 cm	AKDT(HD) 32 - (3 ou 6)	AKFR(HD) 32 - (3 ou 6)
38-43 cm	AKDT(HD) 38 - (3 ou 6)	AKFR(HD) 38 - (3 ou 6)
44-53 cm	AKDT(HD) 44 - (3 ou 6)	AKFR(HD) 44 - (3 ou 6)

EASYLINER

ELDT | ELFR

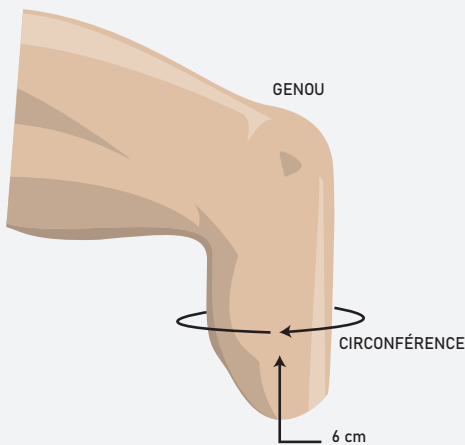
Manchon en gel, tissu renforcé – Avec ou sans attache distale



PRÉSENTATION DU PRODUIT

ALPS™ EasyLiner est un manchon à base de gel EasyGel qui contient de puissants antioxydants dont il est prouvé qu'ils sont très bénéfiques pour la peau du moignon. Grâce à l'EasyGel et au tissu hautes performances, EasyLiner allie parfaitement souplesse, force, élasticité, confort et durabilité.

Pour plus d'informations sur les avantages, veuillez vous référer aux études de cas dans le catalogue de produits.

PRINCIPALES CARACTÉRISTIQUES ET AVANTAGES



TISSU BEIGE
ÉLASTICITÉS
HORIZONTALE ET
VERTICALE



EASYGEL



AVEC
ATTACHE
DISTALE



SANS
ATTACHE
DISTALE



Les coutures renforcées améliorent la durabilité et l'apparence



Tissu hautes performances pour améliorer la durabilité



L'encapsulation plane fournit un confort supplémentaire



Disponible en version 3 mm et 6 mm uniforme et en forme conique de 6 mm à l'extrémité distale jusqu'à 3 mm

SCHÉMA COUPE TRANSVERSALE

3mm Uniform, 6mm Uniform, 6/3mm Conique

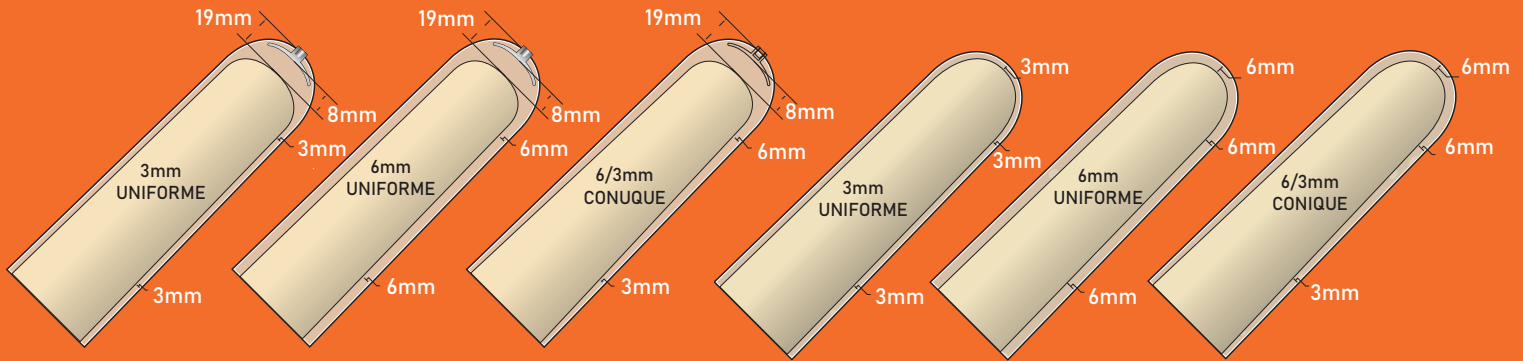

COMMENT MESURER

Prendre les mesures à 6 cm de l'extrémité distale

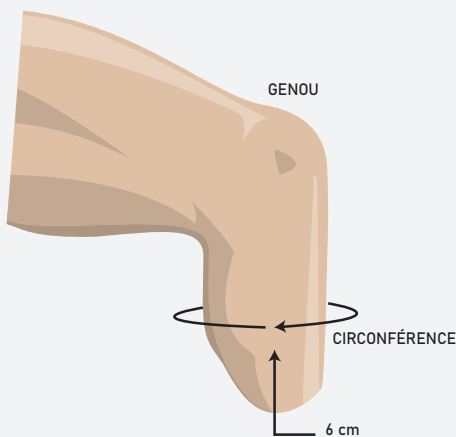

GUIDE DES TAILLES

TAILLE MESURÉE (CM)	AVEC ATTACHE DISTALE 3.0MM, 6MM, 6/3MM, OU 9MM	SANS ATTACHE DISTALE 3.0MM, 6MM, 6/3MM, OU 9MM
16-19 cm	ELDT16 - (3, 6, ou 6/3)	ELFR16 - (3, 6, ou 6/3)
20-23 cm	ELDT20 - (3, 6, ou 6/3)	ELFR20 - (3, 6, ou 6/3)
24-25 cm	ELDT24 - (3, 6, 6/3, ou 9)	ELFR24 - (3, 6, 6/3, ou 9)
26-27 cm	ELDT26 - (3, 6, ou 6/3)	ELRF26 - (3, 6, ou 6/3)
28-31 cm	ELDT28 - (3, 6, 6/3, ou 9)	ELRF28 - (3, 6, 6/3, ou 9)
32-37 cm	ELDT32 - (3, 6, ou 6/3)	ELFR32 - (3, 6, ou 6/3)
38-43 cm	ELDT38 - (3, 6, ou 6/3)	ELFR38 - (3, 6, ou 6/3)
44-53 cm	ELDT44 - (3, 6, ou 6/3)	ELFR44 - (3, 6, ou 6/3)

EasyFlex™ Liner

EZF

Le manchon ALPS® EasyFlex™ permet aux utilisateurs de facilement fléchir le genou grâce à un étirement restreint de façon illimitée à l'avant. À l'arrière, le tissu améliore le contrôle de la jambe prothétique grâce à son étirement vertical limité. L'antioxydant relâché de manière prolongée et contenu dans EasyGel élimine efficacement les radicaux libres et les groupes hydroxyles, ce qui a des effets bénéfiques sur la peau. Le manchon EasyFlex est conçu pour être utilisé avec un système de suspension à plongeur et à accrochage.



Matériau



EasyGel

Tissu



Tissu
beige



Tissu
brun

Niveau d'activité



K1 ✓



K2 ✓



K3



K4

Épaisseur



3 mm



6 mm

Principaux avantages



Indiqué pour les utilisateurs diabétiques et ayant la peau sensible, grâce aux antioxydants contenus dans le gel



Protège le membre résiduel grâce à la haute capacité du EasyGel à absorber les forces verticales et de cisaillement



Soulage encore davantage la peau du stress généré par les forces de cisaillement, grâce à son faible coefficient de friction statique



Facilite la flexion du genou et améliore le contrôle de la jambe prothétique, puisqu'elle a été conçue à l'aide de deux types de tissu aux élasticités différentes



Fourni avec accrochage distal pour systèmes de suspension à plongeur et accrochage

EasyFlex™ Liner EZF. Tableau de tailles.

Mesurer la circonférence du membre résiduel à 6 cm au-dessus de l'extrémité distale.

Taille mesurée (cm)	Locking 3mm ou 6mm uniform
16-19 cm	EZF16-(3 ou 6)
20-23 cm	EZF20-(3 ou 6)
24-25 cm	EZF24-(3 ou 6)
26-27 cm	EZF26-(3 ou 6)
28-31 cm	EZF28-(3 ou 6)
32-37 cm	EZF32-(3 ou 6)
38-43 cm	EZF38-(3 ou 6)
44-53 cm	EZF44-(3 ou 6)

Coupe transversale



EZF

Locking

**MATRICE
RENFORCÉE**

Extrémités distales
plus larges,
proportionnelles à la
taille du manchon

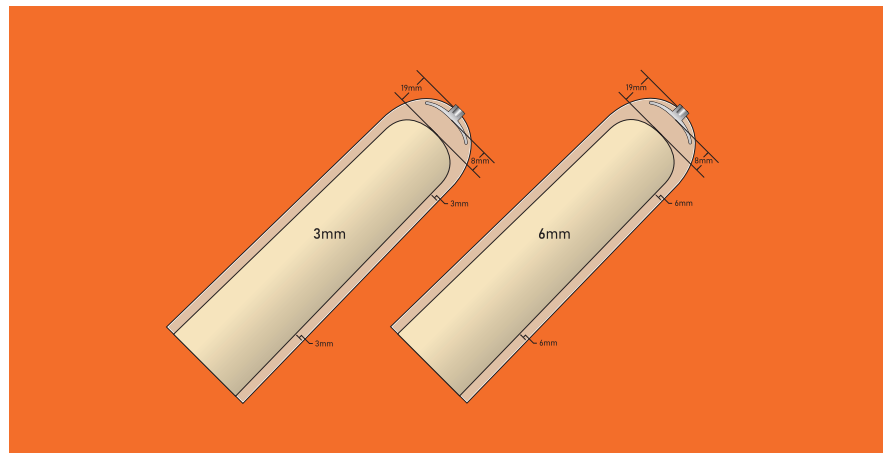

EasyLiner® SuperStretch

ELPX

ALPS® EasyLiner® SuperStretch est un manchon souple, robuste et polyvalent en EasyGel, sans les restrictions liées à un tissu de recouvrement.

Il permet une liberté de mouvement totale et épouse les membres résiduels aux formes irrégulières sans entraver la circulation sanguine. Grâce à son faible coefficient de friction, l'EasyGel soulage la peau du stress créé par les forces de cisaillement. L'antioxydant à libération prolongée a des effets bénéfiques sur la peau.



Matériau



EasyGel

Niveau d'activité



K1 ✓

K2 ✓

K3

K4

Épaisseur



6 mm

Principaux avantages



Indiqué pour les utilisateurs diabétiques et ayant la peau sensible, grâce aux antioxydants contenus dans le gel



Protège le membre résiduel grâce à la haute capacité du EasyGel à absorber les forces verticales et de cisaillement



Soulage encore davantage la peau du stress généré par les forces de cisaillement, grâce à son faible coefficient de friction statique



Fabriqué à base de EasyGel sans tissu de recouvrement permet un ajustement supérieur qui s'adapte aux formes irrégulières sans contraindre le membre résiduel

EasyLiner® SuperStretch ELPX. Tableau de tailles.

Mesurer la circonférence du membre résiduel à 6 cm au-dessus de l'extrémité distale.

Taille mesurée (cm)	Collerette 6mm uniform
10-15 cm	ELPX-10
16-19 cm	ELPX-16
20-23 cm	ELPX-20
24-25 cm	ELPX-24
26-27 cm	ELPX-26
28-31 cm	ELPX-28
32-37 cm	ELPX-32
38-43 cm	ELPX-38

Coupe transversale



ELPX
Collerette

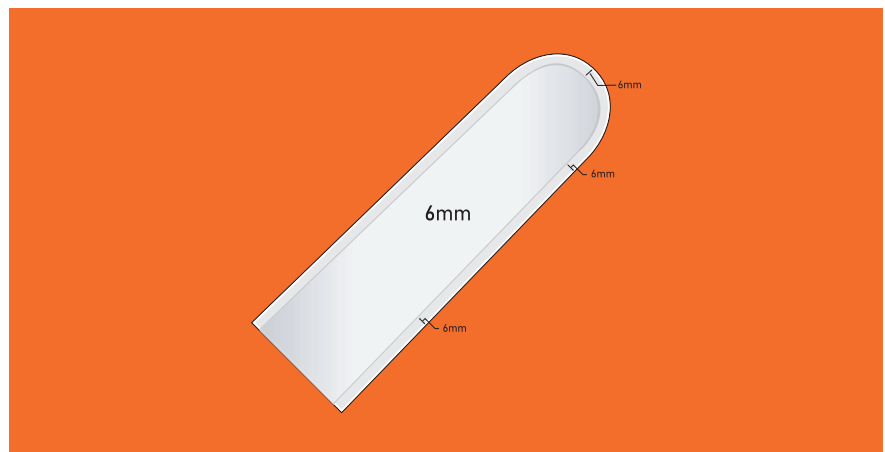

SUPERIOR PERFORMANCE

SPDT (HD) | SPFR (HD)

Manchon en gel de copolymère, tissu renforcé, avec ou sans attache distale



PRÉSENTATION DU PRODUIT

Le manchon ALPS Superior Performance est idéal pour les patients actifs et offre un confort de qualité dans la version GripGel ou HD Gel. Le manchon Superior Performance arbore un NOUVEAU tissu noir garantissant plus de confort et de stabilité.

PRINCIPALES CARACTÉRISTIQUES



SCHÉMA COUPE TRANSVERSALE

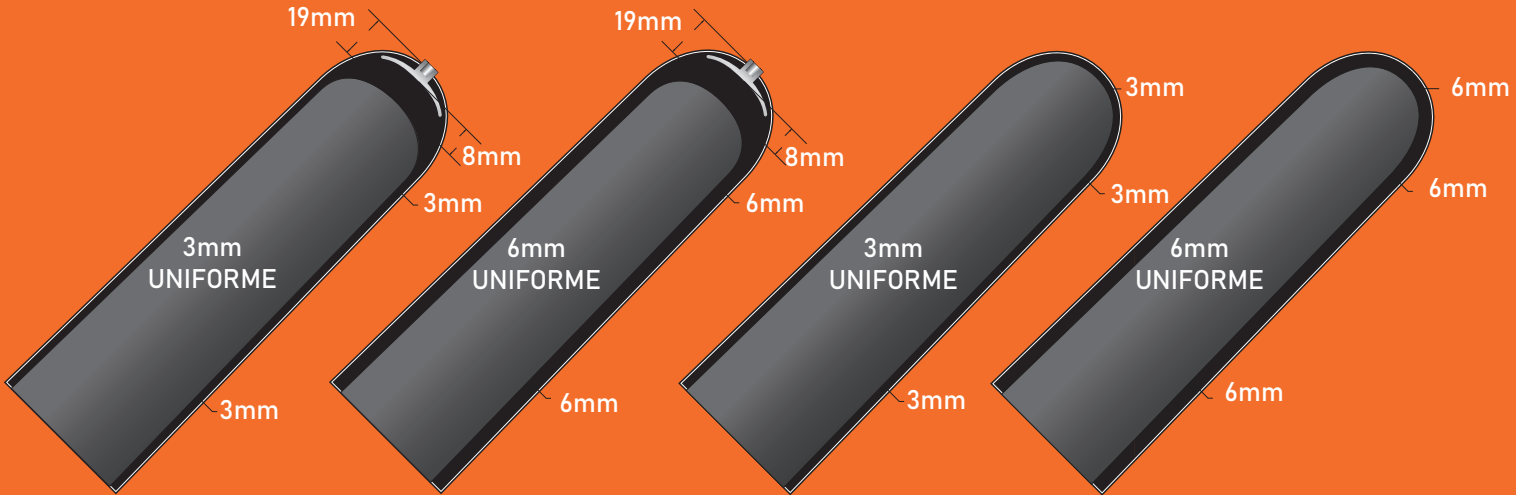

COMMENT MESURER

Prendre les mesures à 6 cm de l'extrémité distale

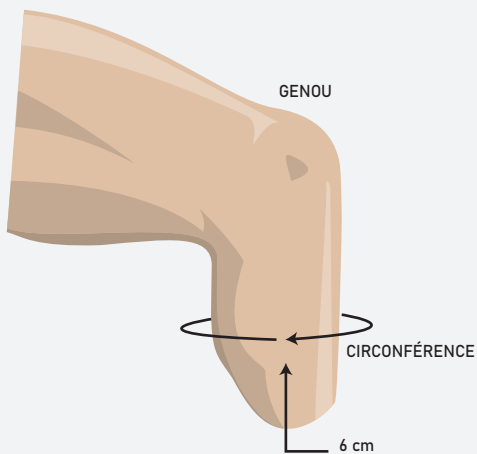

GUIDE DES TAILLES

TAILLE MESURÉE (CM)	AVEC ATTACHE DISTALE 3,0 ou 6,0 MM UNIFORME	SANS ATTACHE DISTALE 3,0 ou 6,0 MM UNIFORME
16-19 cm	SPDT(HD) 16 - (3 ou 6)	SPFR(HD) 16 - (3 ou 6)
20-23 cm	SPDT(HD) 20 - (3 ou 6)	SPFR(HD) 20 - (3 ou 6)
24-25 cm	SPDT(HD) 24 - (3 ou 6)	SPFR(HD) 24 - (3 ou 6)
26-27 cm	SPDT(HD) 26 - (3 ou 6)	SPFR(HD) 26 - (3 ou 6)
28-31 cm	SPDT(HD) 28 - (3 ou 6)	SPFR(HD) 28 - (3 ou 6)
32-37 cm	SPDT(HD) 32 - (3 ou 6)	SPFR(HD) 32 - (3 ou 6)
38-43 cm	SPDT(HD) 38 - (3 ou 6)	SPFR(HD) 38 - (3 ou 6)
44-53 cm	SPDT(HD) 44 - (3 ou 6)	SPFR(HD) 44 - (3 ou 6)

ECO LINER

ECDTHD | ECFRHD

Manchon en gel de copolymère –
avec ou sans attache distale

PRÉSENTATION DU PRODUIT

Le manchon ALPS[®] ECO présente une nouvelle structure distale avec élasticité limitée en vue de prévenir toute extension distale. Outre une fabrication économe en énergie, le manchon ECO affiche un nouveau tissu dépourvu de coutures et au look moderne. Ce manchon est disponible avec ou sans attache distale et en version ALPS HD Gel afin d'offrir un meilleur contrôle aux personnes amputées actives.

PRINCIPALES CARACTÉRISTIQUES

FAIBLE
ÉLASTICITÉ

NOUVELLE STRUCTURE
DISTALE

AVEC ATTACHE DISTALE
ÉPAISSEUR RÉGULIÈRE
3 OU 6 MM



GEL HAUTE
DENSITÉ (HD)

SANS ATTACHE DISTALE
ÉPAISSEUR RÉGULIÈRE
3 OU 6 MM

HAUTE
ÉLASTICITÉ

SCHÉMA COUPE TRANSVERSALE

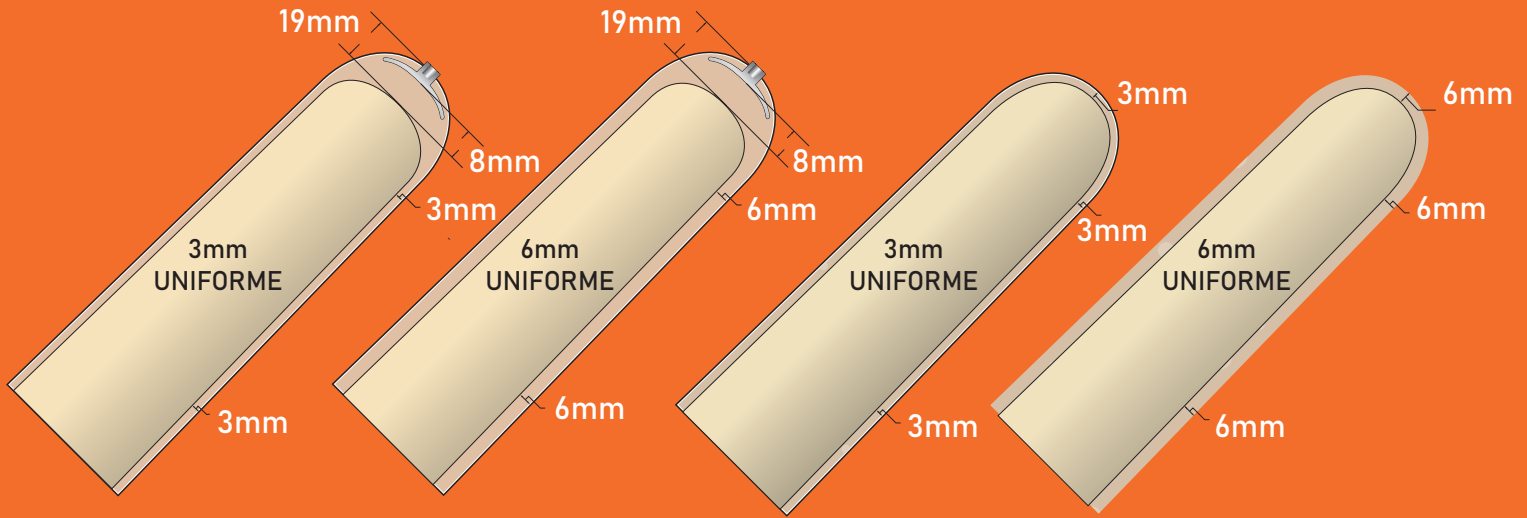

COMMENT MESURER

Prendre les mesures à 6 cm de l'extrémité distale

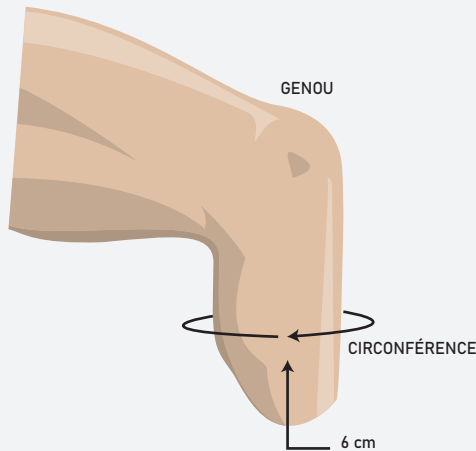

GUIDE DES TAILLES

TAILLE MESURÉE (CM)	U AVEC ATTACHE DISTALE 3,0 ou 6,0 MM UNIFORME	U SANS ATTACHE DISTALE 3,0 ou 6,0 MM UNIFORME
20-23 cm	ECDTHD 20 - (3 ou 6)	ECFRHD 20 - (3 ou 6)
24-25 cm	ECDTHD 24 - (3 ou 6)	ECFRHD 24 - (3 ou 6)
26-27 cm	ECDTHD 26 - (3 ou 6)	ECFRHD 26 - (3 ou 6)
28-31 cm	ECDTHD 28 - (3 ou 6)	ECFRHD 28 - (3 ou 6)
32-37 cm	ECDTHD 32 - (3 ou 6)	ECFRHD 32 - (3 ou 6)
38-43 cm	ECDTHD 38 - (3 ou 6)	ECFRHD 38 - (3 ou 6)
44-53 cm	ECDTHD 44 - (3 ou 6)	ECFRHD 44 - (3 ou 6)

SILICONE PRO

LSL / LSC

Manchon en silicone - Tissu renforcé

PRÉSENTATION DU PRODUIT

Le manchon ALPS™ Silicone Pro est un manchon en silicone de qualité médicale, protégé par le tricot ALPS et disponible avec ou sans attache distale. Ce manchon garantit aux patients une suspension confortable dans leur prothèse et offre une grande liberté de mouvement.



TRICOT

Sans couture, élasticité différenciée, matrice intégrée



AVEC ATTACHE DISTALE

ÉPAISSEUR RÉGULIÈRE 3,0 MM



SANS ATTACHE DISTALE

ÉPAISSEUR RÉGULIÈRE 3,0 MM

PRINCIPALES CARACTÉRISTIQUES



Réduction de 1/5 des phénomènes de friction du silicone standard



Silicone de qualité médicale, protégé par un tricot



Léger



Effet de pistonnage limité



Matériau hypoallergénique et profil fin



Effet rafraîchissant

TEST DE FRICTION



SCHÉMA COUPE TRANSVERSALE

3.0 mm Uniforme

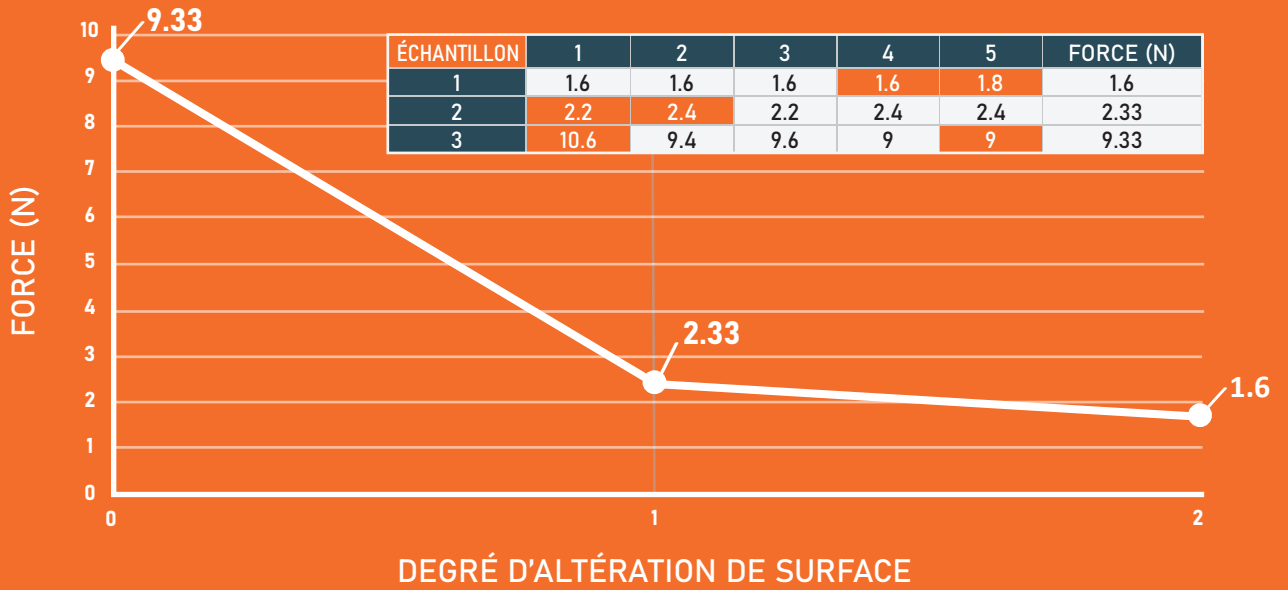
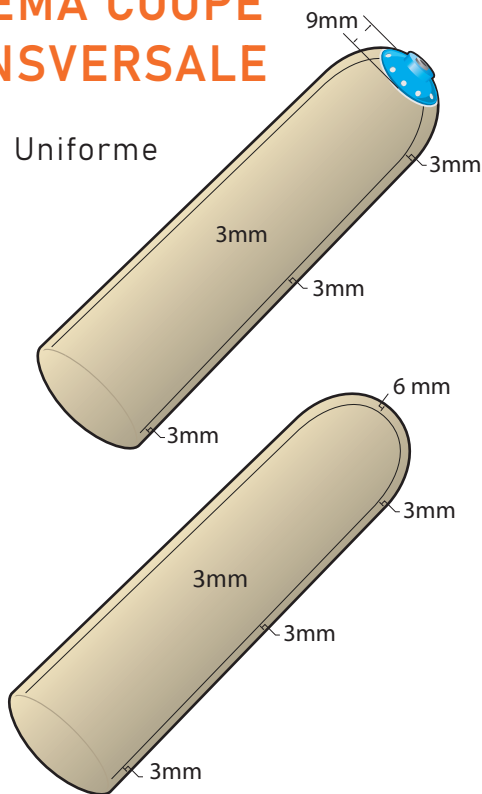

COMMENT MESURER

Prendre les mesures à 6 cm de l'extrémité distale

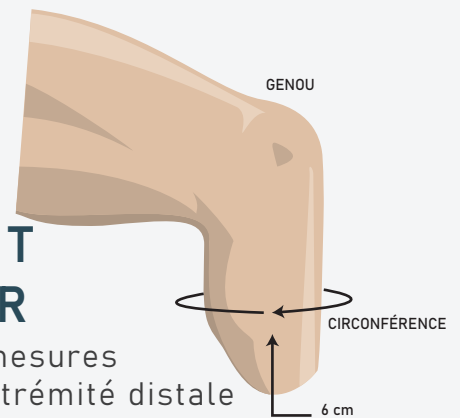

GUIDE DES TAILLES

TAILLE MESURÉE (CM)	AVEC ATTACHE DISTALE 3.0 MM UNIFORME	SANS ATTACHE DISTALE 3.0 MM UNIFORME
20-22 cm	LSL3.0-20	LSC3.0-20
22-24 cm	LSL3.0-22	LSC3.0-22
24-26 cm	LSL3.0-24	LSC3.0-24
26-28 cm	LSL3.0-26	LSC3.0-26
28-30 cm	LSL3.0-28	LSC3.0-28
30-32 cm	LSL3.0-30	LSC3.0-30
32-35 cm	LSL3.0-32	LSC3.0-32
35-38 cm	LSL3.0-35	LSC3.0-35
38-41 cm	LSL3.0-38	LSC3.0-38
41-44 cm	LSL3.0-41	LSC3.0-41
44-47 cm	LSL3.0-44	LSC3.0-44

FLEX SLEEVE

SFX

Genouillère prothétique en gel

PRÉSENTATION DU PRODUIT

La genouillère prothétique ALPS™ Flex (SFX) combine un tissu sans couture et le gel à haute densité pour offrir un confort maximal. La SFX a une pré-flexion de 30°, ce qui permet de plier facilement le genou et réduire la pression sur la zone poplitée.

PRINCIPALES CARACTÉRISTIQUES



Offre une pré-flexion de 30°



Le gel à haute densité (HD) offre aux personnes amputées actives un niveau important de contrôle



Disponible en une longueur qui s'adapte à la plupart des utilisateurs

TRICOT SANS COUTURE

Tricot fabriqué en interne avec des fils de qualité

OPTIONS 2 COULEURS



TISSU NOIR



TISSU BEIGE

SCHÉMA COUPE TRANSVERSALE



3 MM UNIFORME



3 MM UNIFORME

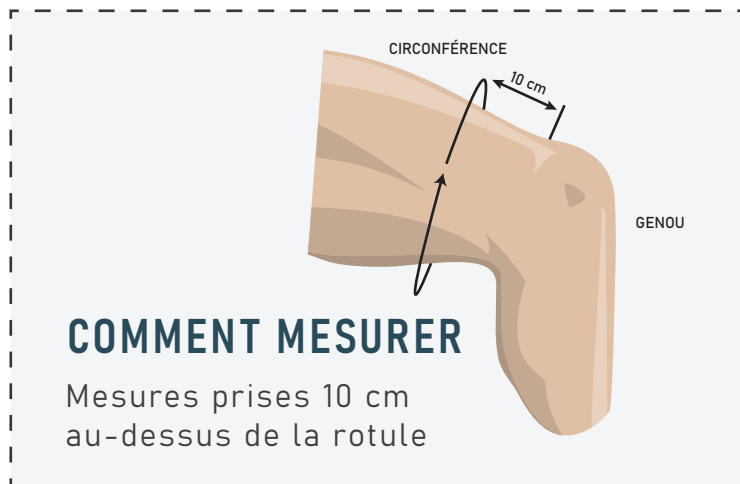

GUIDE DES TAILLES

TAILLE MESURÉE (CM)	U 3.0 MM UNIFORME TISSU BEIGE	U 3.0 MM UNIFORME TISSU NOIR
34-37 cm	SFX20 - 3B	SFX20 - 3G
36-39 cm	SFX23 - 3B	SFX23 - 3G
38-42 cm	SFX26 - 3B	SFX26 - 3G
41-46 cm	SFX29 - 3B	SFX29 - 3G
45-50 cm	SFX32 - 3B	SFX32 - 3G

EasySleeve

SFR

Le manchon à gel ALPS® EasySleeve Reinforced Fabric offre un confort supérieur grâce à son utilisation du ALPS® EasyGel. L'élasticité du tissu offre à l'utilisateur une très grande liberté lors de la flexion du genou. Le EasySleeve permet également une suspension sécurisée grâce à l'étanchéité créée avec la peau, sans limiter la circulation. Le faible coefficient de friction du EasyGel aide à soulager les peaux soumises à des forces de cisaillement.



Matériau



EasyGel

Tissu



Tissu
beige

Niveau d'activité



K1 ✓



K2 ✓



K3



K4

Épaisseur



3 mm

6 mm

Principaux avantages



Facile à enfiler, même pour les utilisateurs dont la dextérité manuelle est réduite



Indiqué pour les peaux délicates et fragiles grâce aux antioxydants contenus dans le gel



Limite la compression et l'irritation en zone proximale



Offre un degré de liberté élevé pour la flexion du genou



Soulage la peau du stress généré par les forces de cisaillement grâce au faible coefficient de friction statique du EasyGel

EasySleeve SFR. Tableau de tailles.

Mesurer la circonférence de la jambe à 10 cm au-dessus du centre du genou.

Taille mesurée (cm)	3mm ou 6mm uniform
16-19 cm	SFR10-(3 ou 6)
20-24 cm	SFR16-(3 ou 6)
25-30 cm	SFR20-(3 ou 6)
31-34 cm	SFR24-(3 ou 6)
35-37 cm	SFR26-(3 ou 6)
38-40 cm	SFR28-(3 ou 6)
41-45 cm	SFR32-(3 ou 6)
46-60 cm	SFR38-(3 ou 6)
61-70 cm	SFR44-(3 ou 6)

Coupe transversale

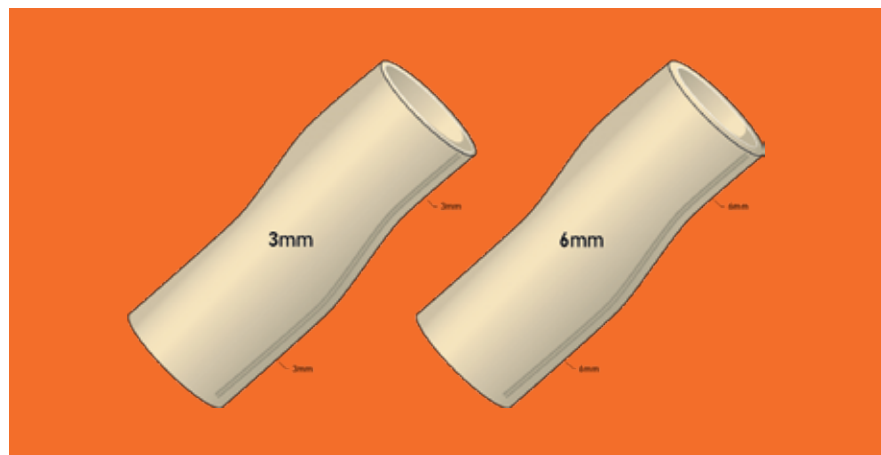

COUVRE-MOIGNONS

KCN | KCM | KCW



Le couvre-moignon ALPS™ est léger et souple, et permet d'amortir en donnant plus de confort.

SPÉCIFICATIONS PRODUIT

	TROIS STYLES
ÉTROIT, MOYEN ET LARGE	TROIS TAILLES
1, 3 ET 5 PLIS	TROIS ÉPAISSEURS
TRÈS COURT, COURT, MOYEN ET LONG	QUATRE LONGUEURS



POINTS FORTS

-  Aide face aux variations de volume
-  Les fibres techniques permettent une tenue cool et confortable
-  Conserve sa forme au fil du temps ; étirement minimal, ne se rigidifie pas
-  **DÉSORMAIS DISPONIBLE EN LOTS !**
Une solution complète pour que les utilisateurs gèrent mieux les variations de volume du membre résiduel. Les épaisseurs les plus demandées sont à portée de main.



FABRIQUÉ AVEC DES FIBRES TECHNIQUES PREMIUM

CRÉE UN SYSTÈME DE GESTION DE L'HUMIDITÉ, POUR ÉLOIGNER LA TRANSPIRATION DU CORPS À TRAVERS LE TISSU, OÙ ELLE PEUT S'ÉVAPORER RAPIDEMENT.

AVEC LES LOTS, VOTRE UTILISATEUR PEUT :

- Sélectionner les couvre-moignons dont il a besoin pour gérer les variations de volume
- Toujours avoir des couvre-moignons disponibles lorsque les autres sont à laver

DIAGRAMME D'AJUSTEMENT

Il est recommandé
 que le couvre-moignon soit
 environ 5 cm plus long
 que l'emboîture prothétique

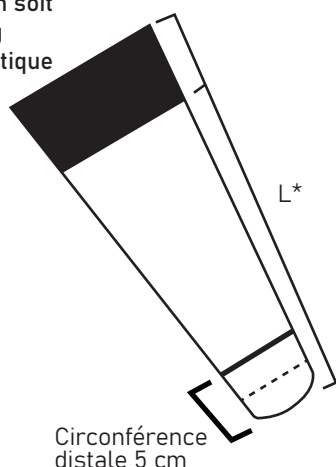

COMMENT MESURER

Mesures prise à 5 cm
 de l'extrémité distale



TABLEAU DE TAILLES

TROUVEZ L'AJUSTEMENT PARFAIT.

TAILLE DE MANCHON RECOMMANDÉE PAR ALPS	NIVEAU D'AMPUTATION	CIRCONFÉRENCE PROXIMALE	CIRCONFÉRENCE DISTALE À (5 cm)	*TAILLE DE L'EMBOÎTURE PROTHÉTIQUE 13-18 CM	*TAILLE DE L'EMBOÎTURE PROTHÉTIQUE 18-23 CM	*TAILLE DE L'EMBOÎTURE PROTHÉTIQUE 23-38 CM	*TAILLE DE L'EMBOÎTURE PROTHÉTIQUE 38-48 CM
20	BK	min. 20-max. 40 cm	20-23 cm	KCN-8-X-Y	KCN-10-X-Y	KCN-14-X-Y	KCN-18-X-Y
24, 26, 28	BK	min. 30-max. 60 cm	23-31 cm	KCM-8-X-Y	KCM-10-X-Y	KCM-14-X-Y	KCM-18-X-Y
32, 38	AK	min. 40-max. 80 cm	31-36 cm	KCW-8-X-Y	KCW-10-X-Y	KCW-14-X-Y	KCW-18-X-Y

X indique l'épaisseur en plis (1 pli = 1,5 mm ; 3 plis = 2 mm ; 5 plis = 2,5 mm)

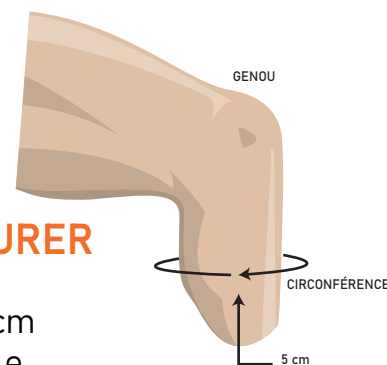
Y indique l'extrémité distale (N sans orifice ; H avec orifice ; HR avec orifice renforcé)

EXEMPLES :

Couvre-moignon KCN-08-3-H, étroit, très court, 3 plis, avec orifice

Couvre-moignon KCM-10-1-N, moyen, court, 1 pli, sans orifice

Couvre-moignon KCW-18-5-HR, large, long, 5 plis, avec orifice renforcé

VACUUM INTEGRATED PUMP





VIP



PRÉSENTATION DU PRODUIT

Le ALPS™ VIP est une valve d'expulsion d'air intégrée pour vide élevé pour emboîture prothétique. VIP offre au patient un contact continu et total à l'emboîtement de sa prothèse. Ce système garantit une répartition uniforme du poids et une bonne distribution de la suspension de la prothèse sur toute la surface du moignon. Le vide élevé généré par le VIP stabilise le moignon, prévenant ainsi tous les problèmes liés à la variation du volume du moignon au cours de la journée.

AVANTAGES

-  Gère les variations du volume du moignon avec efficacité, conduisant ainsi à un meilleur contrôle de la prothèse et à un plus grand confort
-  Réduit l'intensité des pics de pression sur les membres du patient, offrant ainsi un meilleur confort et une plus grande liberté de mouvement
-  Aide à préserver la santé cutanée du moignon en améliorant la circulation et donc l'oxygénation du membre
-  N'a aucun impact sur l'apparence esthétique de la prothèse

Facile à
mettre

Améliore la
circulation
sanguine

Améliore
le confort

Améliore la
marche

Silencieux

Léger

DISPONIBLE AVEC 2 NIVEAUX DE VIDE DIFFÉRENTS

VIDE POUSSÉ (rouge)
 10-13 pouces de mercure

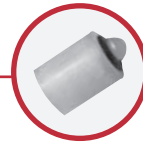

Nous recommandons vivement d'utiliser la **mini-valve** afin de prévenir toute extension distale.

VIDE GROSSIER (vert)
 5-8 pouces de mercure



CHOISISSEZ LE NIVEAU SELON :

NIVEAU D'ACTIVITÉ

ÉTAT DE LA PEAU

SANS PLAQUE DE FIXATION

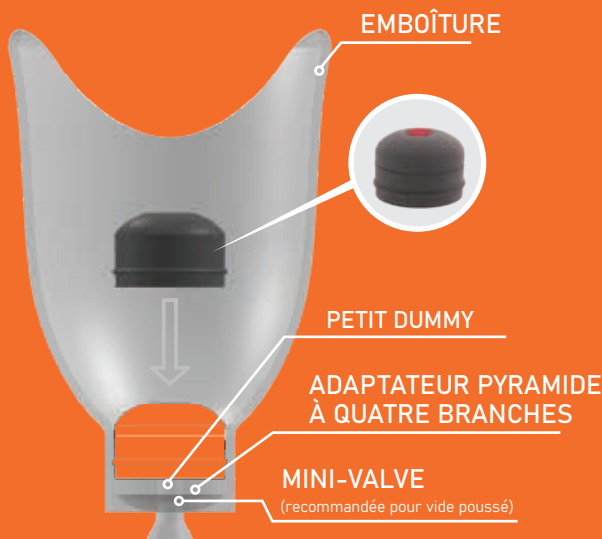

AVEC PLAQUE DE FIXATION

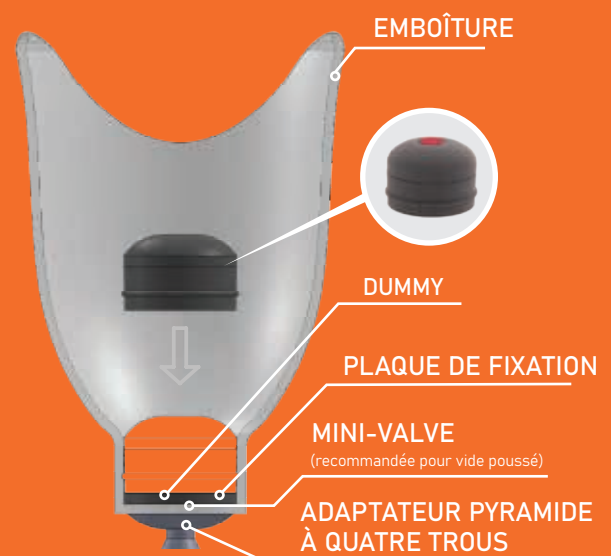

CARACTÉRISTIQUES DU PRODUIT

	VIDE POUSSÉ (ROUGE)	VIDE GROSSIER (VERT)
RÉF.	VIP - DH	VIP - DL
DIAMÈTRE	66MM	66MM
HAUTEUR	48MM	48MM
POIDS	75G	64G
MATÉRIAU	SILICONE	SILICONE





































CODES À INDIQUER DANS COMMANDE

NOM DE L'ARTICLE	RÉF.
DUMMY	VE319 - D
PETIT DUMMY	VE319 - SD
PLAQUE DE FIXATION	VE819 - P
VERROU (PETIT)	VIP-L1120-S
MINI-VALVE (vivement recommandée)	MV-009
KIT MINI-VALVE	LMV-009
PIN (4.8cm)	VIP-92L
PIN (3.0cm)	VIP-92S





PRODOTTI

PRODOTTI						
Immagine	Nome	Codice	Tipo	Materiale	Spessore	Caratteristiche
	General Purpose Liner	GPDT GPFR	 	 GripGel	Uniforme 3 o 6 mm	Adatta per bassi livelli di Grip Gel attività e pelli sane
	Extreme Liner	AKDT AKFR AKDTHD AKFRH	 	 HD Gel  GripGel	Uniforme 3 o 6 mm	Consigliata per pazienti transfemorali e per transtibiali attivi
	Easy Liner	ELDT ELFR	 	 EasyGel	Uniforme 3 o 6 mm; rastremata 6 mm distale/3mm prossimale	Per pazienti con pelli sensibili
	Easy Flex Liner	EZF		 EasyGel	Uniforme 3 o 6 mm	Adatta a pelli delicate e a pazienti diabetici grazie all'agente antiossidante contenuto nel gel
	Easy Liner Super Stretch	ELPX		 EasyGel	Uniforme 6 mm	Adatta a pelli delicate e a pazienti diabetici grazie all'agente antiossidante contenuto nel gel
	Superior Performance Liner	SPDT SPFR SPDTHD SPFRHD	 	 HD Gel  GripGel	Uniforme 3 o 6 mm	Caratterizzata dal tessuto nero che garantisce controllo e stabilità. Ideale per pazienti attivi
	ECO Liner	ECDTHD ECFRHD	 	 HD Gel	Uniforme 3 o 6 mm	La sua innovativa struttura limita l'elasticità a livello distale
	Silicone PRO	LSC LSL	 	 Silicone	Uniforme 3 mm	Cuffia in silicone delicata sulla pelle, ricoperta da tessuto per comfort e durata ottimali
	Flex Sleeve	SFX		 HD Gel	Uniforme 3 mm	Ginocchiera pre-flessa di 30°
	Easy Sleeve	SFR		 EasyGel	Uniforme 3 o 6 mm	Per pelli sensibili

GENERAL PURPOSE

GPDT | GPFR

Cuffia in gel, rinforzata,
con o senza attacco distale



DESCRIZIONE

La cuffia General Purpose Gel Liner è stata concepita per pazienti con basso livello di attività. È disponibile in ALPS™ GripGel per offrire comfort, robustezza ed elasticità. La cuffia GP è facile da indossare e, grazie alla sua grande capacità di allungamento, non limita la circolazione sanguigna dell'arto residuo.

CARATTERISTICHE E BENEFICI PRINCIPALI



Il tessuto di rivestimento High Performance assicura una maggiore durata



L'aderenza aiuta a contenere l'eccesso di tessuto in area popliteale



Disponibile in uno spessore uniforme di 3mm e 6mm



TESSUTO BEIGE
ALLUNGAMENTO VERTICALE
E ORIZZONTALE



CON
ATTACCO



GRIPGEL



SENZA
ATTACCO

SEZIONE TRASVERSALE

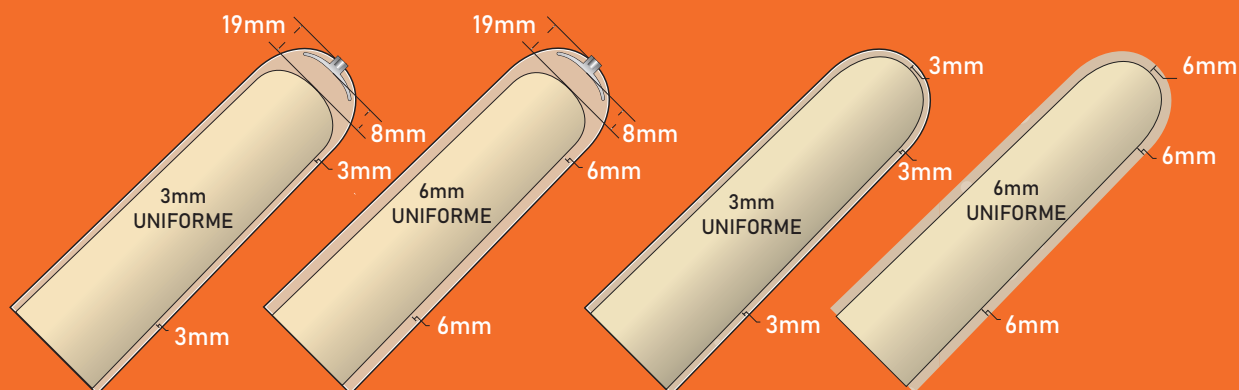

COME SCEGLIERE LA TAGLIA

Misurare la circonferenza a 6 cm dall'apice distale



TABELLA MISURE

CIRCONFERENZA (CM)	CON ATTACCO 3MM o 6MM UNIFORME	SENZA ATTACCO 3MM o 6MM UNIFORME
16-19 cm	GPDT16 - (3 o 6)	GPFR16 - (3 o 6)
20-23 cm	GPDT20 - (3 o 6)	GPFR20 - (3 o 6)
24-25 cm	GPDT24 - (3 o 6)	GPFR24 - (3 o 6)
26-27 cm	GPDT26 - (3 o 6)	GPRF26 - (3 o 6)
28-31 cm	GPDT28 - (3 o 6)	GPRF28 - (3 o 6)
32-37 cm	GPDT32 - (3 o 6)	GPFR32 - (3 o 6)
38-43 cm	GPDT38 - (3 o 6)	GPFR38 - (3 o 6)
44-53 cm	GPDT44 - (3 o 6)	GPFR44 - (3 o 6)

EXTREME LINER

AKDT | AKFR
AKDTHD | AKFRHD

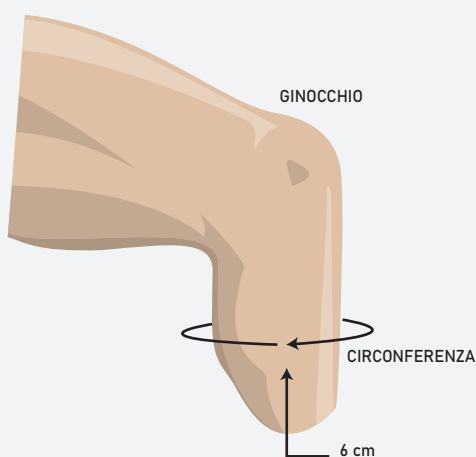



Per pazienti transfemorali
e transtibiali attivi –
Con o senza attacco distale



DESCRIZIONE

La cuffia ALPS™ Extreme Liner è specificamente pensata per amputati transfemorali e transtibiali attivi. E' disponibile in Gel ad Alta Densità (HD) o in Grip Gel gel per garantire il massimo comfort. Ha un allungamento verticale ridotto dell'80%, che assicura un maggior controllo e stabilità della protesi.

CARATTERISTICHE E BENEFICI PRINCIPALI

-  Il tessuto marrone limita l'allungamento verticale e riduce il movimento dei tessuti molli
-  L'aderenza aiuta a contenere l'eccesso di tessuto in area popliteale
-  Ombrello distale proporzionato alla misura della cuffia per facilitare l'indossamento
-  Disponibile in uno spessore uniforme di 3mm e 6mm

 SENZA
ATTACCO

 CON
ATTACCO

 GRIPGEL

 HIGH DENSITY
(HD) GEL

SEZIONE TRASVERSALE

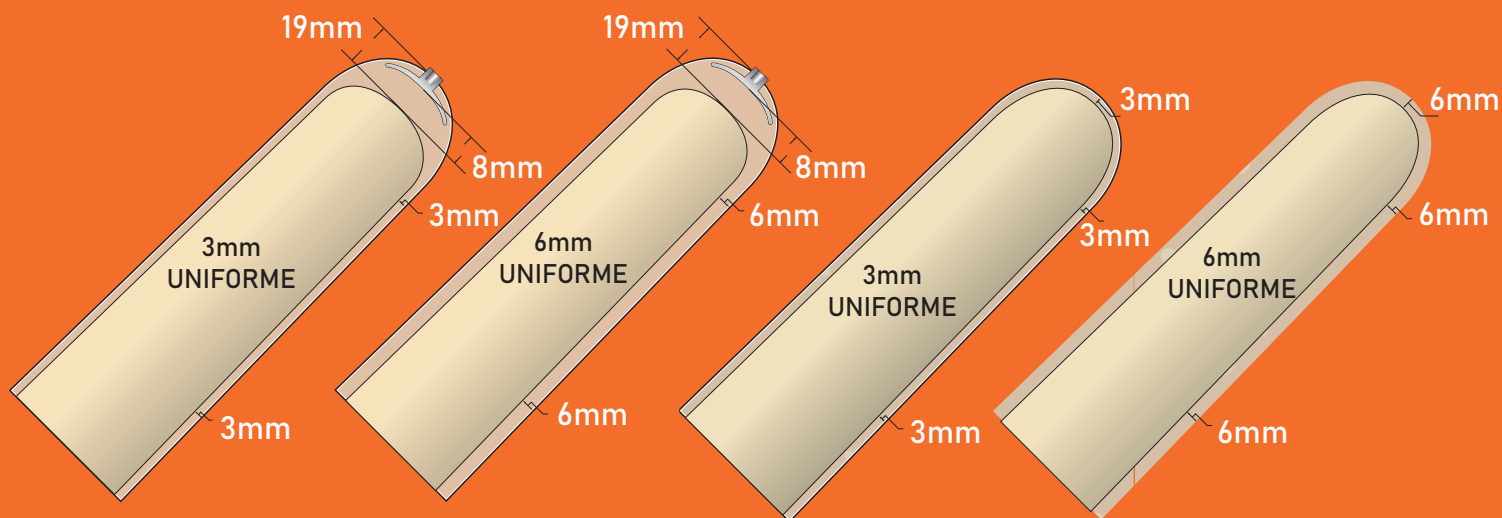

COME SCEGLIERE LA TAGLIA

Misurare la circonferenza a 6 cm dall'apice distale



TABELLA MISURE

CIRCONFERENZA (CM)	CON ATTACCO 3MM o 6MM UNIFORME	SENZA ATTACCO 3MM o 6MM UNIFORME
16-19 cm	AKDT(HD) 16 - (3 o 6)	AKFR(HD) 16 - (3 o 6)
20-23 cm	AKDT(HD) 20 - (3 o 6)	AKFR(HD) 20 - (3 o 6)
24-25 cm	AKDT(HD) 24 - (3 o 6)	AKFR(HD) 24 - (3 o 6)
26-27 cm	AKDT(HD) 26 - (3 o 6)	AKFR(HD) 26 - (3 o 6)
28-31 cm	AKDT(HD) 28 - (3 o 6)	AKFR(HD) 28 - (3 o 6)
32-37 cm	AKDT(HD) 32 - (3 o 6)	AKFR(HD) 32 - (3 o 6)
38-43 cm	AKDT(HD) 38 - (3 o 6)	AKFR(HD) 38 - (3 o 6)
44-53 cm	AKDT(HD) 44 - (3 o 6)	AKFR(HD) 44 - (3 o 6)

EASYLINER

ELDT | ELFR

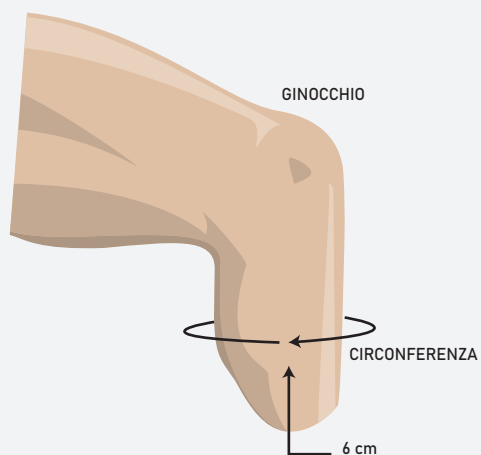
Cuffia in gel, rinforzata,
con o senza attacco distale



DESCRIZIONE

La cuffia ALPS™ EasyLiner è formulata con EasyGel, che contiene potenti antiossidanti benefici per la pelle dell'arto residuo. Grazie all'EasyGel ed al tessuto ad alte prestazioni, l'EasyLiner offre una combinazione perfetta di morbidezza, forza, elasticità, capacità di smorzamento, comfort e durata.

Prove a sostegno dei suddetti effetti benefici sono riportate nel catalogo prodotti.

CARATTERISTICHE E BENEFICI PRINCIPALI



TESSUTO BEIGE
ALLUNGAMENTO VERTICALE
E ORIZZONTALE



EASYGEL



**CON
ATTACCO**



**SENZA
ATTACCO**

- ✓ Le cuciture rinforzate migliorano durata e aspetto
- ✓ Il tessuto ad alte prestazioni migliora la durata
- ✓ L'incapsulamento piatto offre un maggior comfort
- ✓ Disponibile in uno spessore uniforme di 3 mm o 6 mm e rastremata da 6 mm all'estremità distale a 3 mm all'estremità prossimale

SEZIONE TRASVERSALE

3mm uniform, 6mm uniform, 6/3mm rastremata

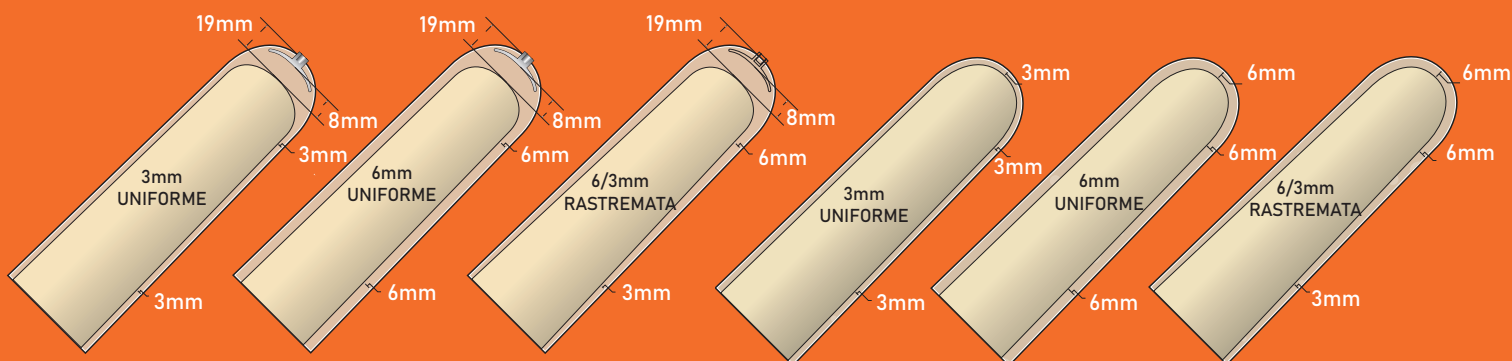

COME SCEGLIERE LA TAGLIA

Misurare la circonferenza a 6 cm dall'apice distale



TABELLA MISURE

CIRCONFERENZA (CM)	CON ATTACCO 3.0MM, 6MM, 6/3MM, O 9MM	SENZA ATTACCO 3.0MM, 6MM, 6/3MM, O 9MM
16-19 cm	ELDT16 - (3, 6, o 6/3)	ELFR16 - (3, 6, o 6/3)
20-23 cm	ELDT20 - (3, 6, o 6/3)	ELFR20 - (3, 6, o 6/3)
24-25 cm	ELDT24 - (3, 6, 6/3, o 9)	ELFR24 - (3, 6, 6/3, o 9)
26-27 cm	ELDT26 - (3, 6, o 6/3)	ELRF26 - (3, 6, o 6/3)
28-31 cm	ELDT28 - (3, 6, 6/3, o 9)	ELRF28 - (3, 6, 6/3, o 9)
32-37 cm	ELDT32 - (3, 6, o 6/3)	ELFR32 - (3, 6, o 6/3)
38-43 cm	ELDT38 - (3, 6, o 6/3)	ELFR38 - (3, 6, o 6/3)
44-53 cm	ELDT44 - (3, 6, o 6/3)	ELFR44 - (3, 6, o 6/3)

EasyFlex™ Liner

EZF

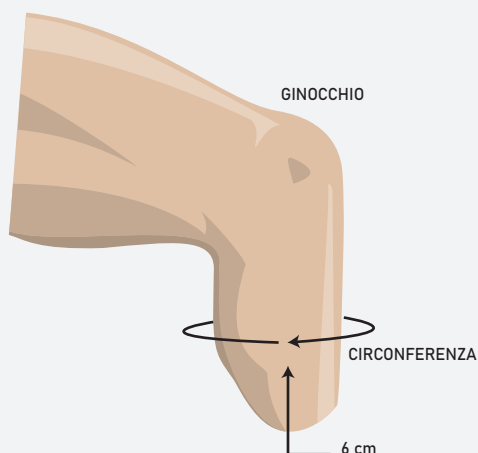
La cuffia protesica ALPS® EasyFlex™ consente al paziente un'agevole flessione del ginocchio grazie al tessuto anteriore elastico. Posteriormente, il tessuto con estensione verticale limitata aumenta il controllo della protesi. L'agente antiossidante contenuto all'interno dell'EasyGel a rilascio graduale neutralizza i radicali liberi ed i gruppi ossidrilici, con effetti benefici sulla pelle. La cuffia EasyFlex™ è utilizzabile con sistemi di sospensione a perno.



Materiale



EasyGel

Tessuto



Tessuto
Beige



Tessuto
Marrone

Livello attività



K1 ✓



K2 ✓



K3



K4

Spessore



3 mm



6 mm

Benefici



Adatta a pelli delicate e a pazienti diabetici grazie all'agente antiossidante contenuto nel gel



Protegge l'arto residuo per effetto dell'elevata capacità dell'Easygel di assorbire le forze verticali e di taglio



Allevia ulteriormente la pelle dalle sollecitazioni create dalle forze di taglio grazie al suo basso coefficiente di attrito



Agevola la flessione del ginocchio e aumenta il controllo della protesi tramite l'utilizzo di due tessuti a diversa elasticità



Con attacco distale per l'utilizzo nei sistemi di sospensione a perno

EasyFlex™ Liner EZF. Tabella misure.

Misurare la circonferenza a 6 cm dall'apice distale.

Circonferenza misurata (cm)	Con ancoraggio distale 3mm o 6mm uniforme
16-19 cm	EZF16-(3 o 6)
20-23 cm	EZF20-(3 o 6)
24-25 cm	EZF24-(3 o 6)
26-27 cm	EZF26-(3 o 6)
28-31 cm	EZF28-(3 o 6)
32-37 cm	EZF32-(3 o 6)
38-43 cm	EZF38-(3 o 6)
44-53 cm	EZF44-(3 o 6)

Sospensioni



EZF

**Con ancoraggio
distale**

**MATRICE
RINFORZATA**

**Ombrello distale
proporzionato alla
misura della cuffia**

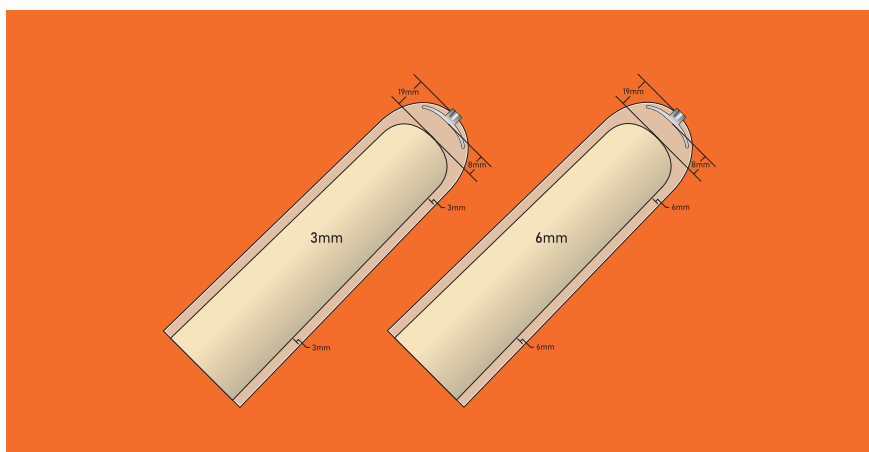

EasyLiner® SuperStretch

ELPX

ALPS® EasyLiner® SuperStretch è una cuffia morbida, robusta e versatile realizzata in EasyGel senza la limitazione del rivestimento in tessuto. Consente una completa libertà di movimento e si adatta anche ad arti residui di forma irregolare senza costringere la circolazione. Grazie al basso coefficiente di attrito dell'EasyGel, allevia la pelle dalle sollecitazioni create dalle forze di taglio. L'agente antiossidante a rilascio graduale ha effetti benefici sulla pelle.



Materiale



EasyGel

Livello di attività



K1 ✓

K2 ✓

K3

K4

Spessore



6 mm

Benefici



Adatta a pelli delicate e a pazienti diabetici grazie all'agente antiossidante contenuto nel gel



Protegge l'arto residuo per effetto dell'elevata capacità dell'EasyGel di assorbire le forze verticali e di taglio



Allevia ulteriormente la pelle dalle sollecitazioni create dalle forze di taglio grazie al suo basso coefficiente di attrito



Realizzata in EasyGel senza tessuto per consentire la massima adattabilità ai monconi di forma irregolare senza creare costrizioni

EasyLiner® SuperStretch ELPX. Tabella misure.

Misurare la circonferenza a 6 cm dall'apice distale.

Circonferenza misurata (cm)	Senza ancoraggio distale 6mm uniforme
10-15 cm	ELPX-10
16-19 cm	ELPX-16
20-23 cm	ELPX-20
24-25 cm	ELPX-24
26-27 cm	ELPX-26
28-31 cm	ELPX-28
32-37 cm	ELPX-32
38-43 cm	ELPX-38

Sospensioni



ELPX

**Senza ancoraggio
distale**

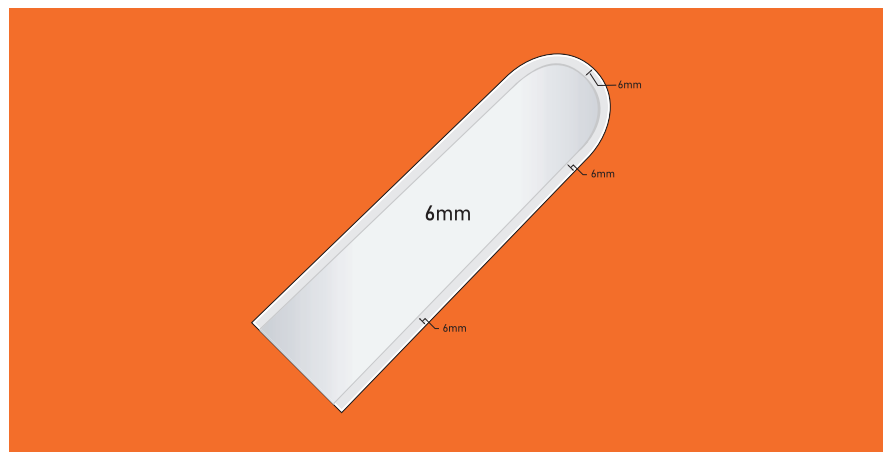

SUPERIOR PERFORMANCE

SPDT (HD) | SPFR (HD)

Cuffia in gel, rinforzata,
con o senza attacco distale



DESCRIZIONE

La cuffia ALPS Superior Performance è ideale per pazienti attivi e offre un comfort superiore grazie ai gel ALPS GripGel o Gel HD. La cuffia SP presenta un NUOVO tessuto nero che garantisce ulteriore comfort e stabilità.

CARATTERISTICHE PRINCIPALI

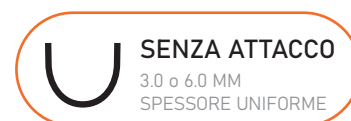
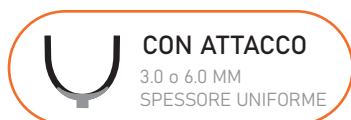

SEZIONE TRASVERSALE

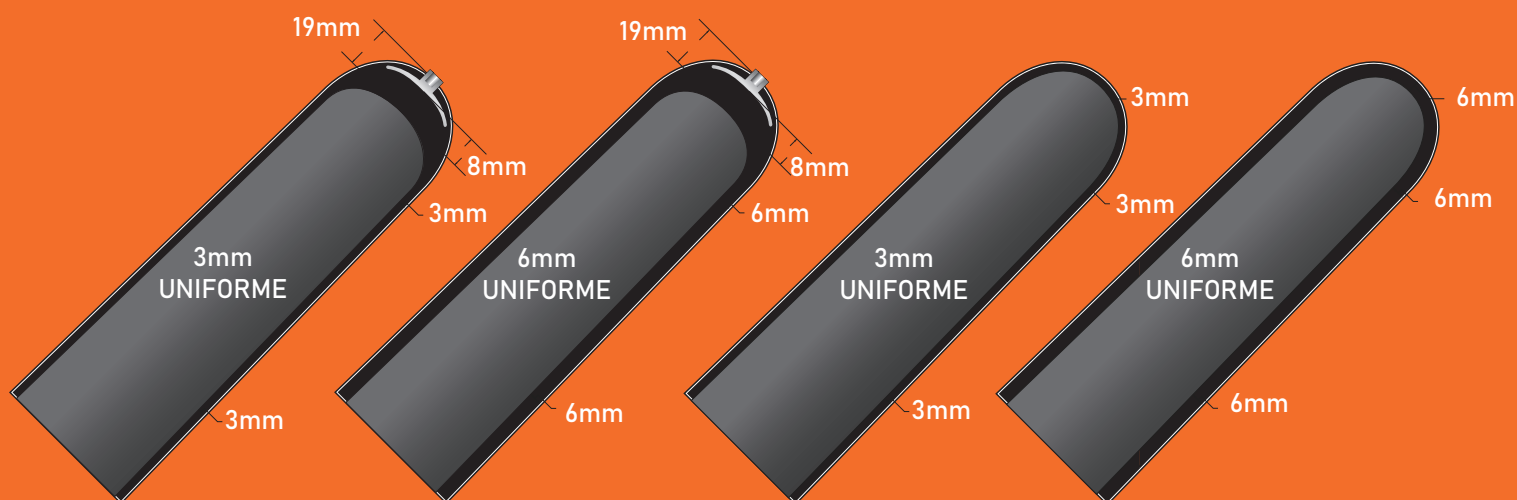

COME SCEGLIERE LA TAGLIA

Misurare la circonferenza a 6 cm dall'apice distale



TABELLA MISURE

CIRCONFERENZA (CM)	CON ATTACCO 3MM o 6MM UNIFORME	SENZA ATTACCO 3MM o 6MM UNIFORME
16-19 cm	SPDT(HD) 16 - (3 o 6)	SPFR(HD) 16 - (3 o 6)
20-23 cm	SPDT(HD) 20 - (3 o 6)	SPFR(HD) 20 - (3 o 6)
24-25 cm	SPDT(HD) 24 - (3 o 6)	SPFR(HD) 24 - (3 o 6)
26-27 cm	SPDT(HD) 26 - (3 o 6)	SPFR(HD) 26 - (3 o 6)
28-31 cm	SPDT(HD) 28 - (3 o 6)	SPFR(HD) 28 - (3 o 6)
32-37 cm	SPDT(HD) 32 - (3 o 6)	SPFR(HD) 32 - (3 o 6)
38-43 cm	SPDT(HD) 38 - (3 o 6)	SPFR(HD) 38 - (3 o 6)
44-53 cm	SPDT(HD) 44 - (3 o 6)	SPFR(HD) 44 - (3 o 6)

ECO LINER

ECDTHD | ECFRHD

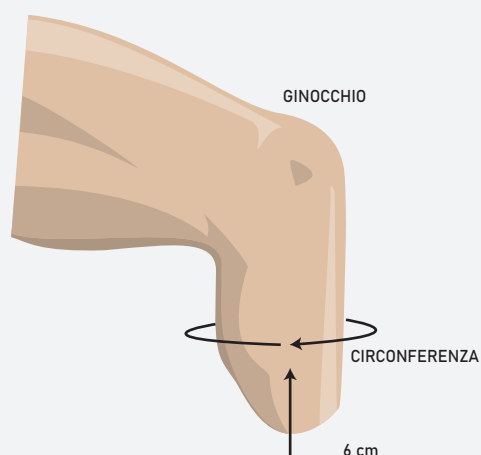
Cuffia in gel – con o senza attacco distale

DESCRIZIONE

La cuffia ALPS™ ECO Liner presenta una nuova struttura che limita l'elasticità a livello distale. Oltre a impiegare meno energia nel processo produttivo, la cuffia ECO Liner è caratterizzata da una innovativa costruzione senza cuciture che le conferisce un aspetto elegante. E' disponibile con o senza ancoraggio distale ed in Gel ad alta densità (HD) per offrire agli amputati attivi il massimo controllo.

CARATTERISTICHE PRINCIPALI

ELASTICITA'
LIMITATA

NUOVA COSTRUZIONE
DISTALE



CON ATTACCO
3.0 o 6.0 MM SPESSORE
UNIFORME



HIGH DENSITY
(HD) GEL



SENZA ATTACCO
3.0 o 6.0 MM
SPESSORE UNIFORME

ELASTICITA'
ELEVATA

SEZIONE TRASVERSALE

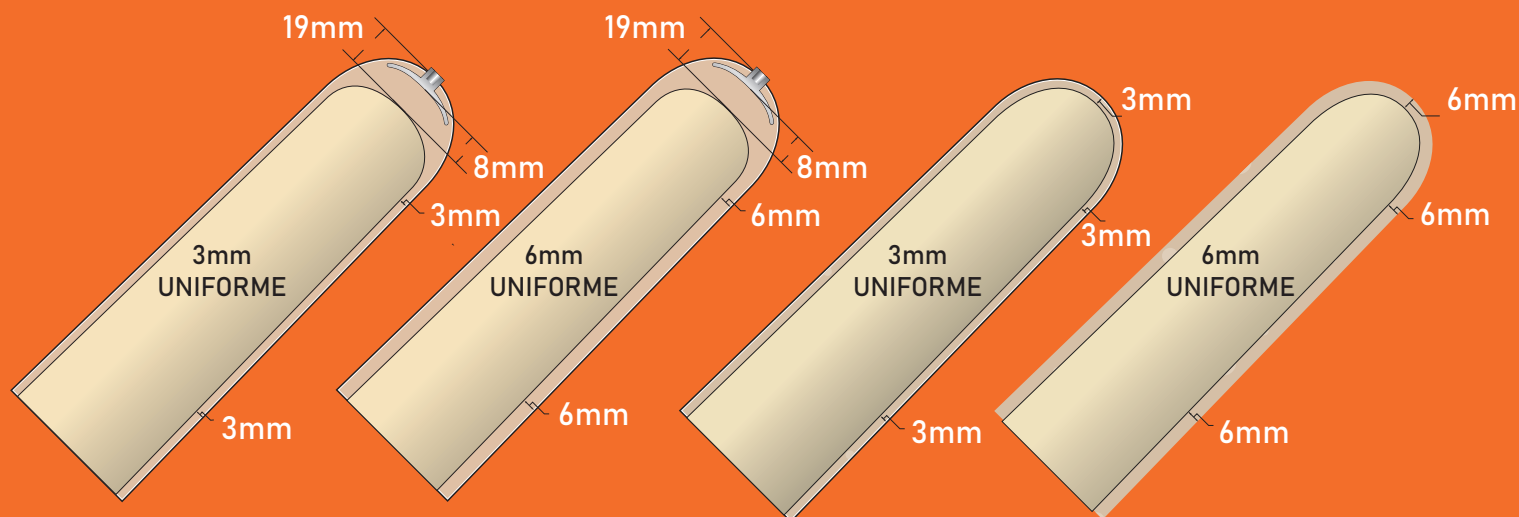

COME SCEGLIERE LA TAGLIA

Misurare la circonferenza a 6 cm dall'apice distale.



TABELLA MISURE

CIRCONFERENZA (CM)	CON ATTACCO 3MM o 6MM UNIFORME	SENZA ATTACCO 3MM o 6MM UNIFORME
20-23 cm	ECDTHD 20 - (3 o 6)	ECFRHD 20 - (3 o 6)
24-25 cm	ECDTHD 24 - (3 o 6)	ECFRHD 24 - (3 o 6)
26-27 cm	ECDTHD 26 - (3 o 6)	ECFRHD 26 - (3 o 6)
28-31 cm	ECDTHD 28 - (3 o 6)	ECFRHD 28 - (3 o 6)
32-37 cm	ECDTHD 32 - (3 o 6)	ECFRHD 32 - (3 o 6)
38-43 cm	ECDTHD 38 - (3 o 6)	ECFRHD 38 - (3 o 6)
44-53 cm	ECDTHD 44 - (3 o 6)	ECFRHD 44 - (3 o 6)

SILICONE PRO

LSL / LSC

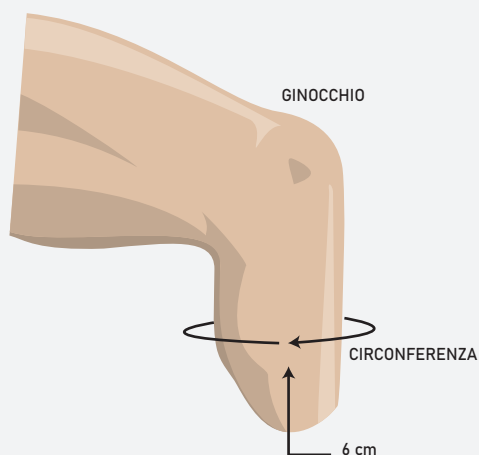
Cuffia in silicone - Con tessuto di rinforzo

DESCRIZIONE

ALPS™ Silicone Pro è una cuffia protesica in silicone medicale protetta da un tessuto "knitted" ed è disponibile con o senza attacco distale. La cuffia offre una comoda sospensione garantendo libertà di movimento.

 **TESSUTO "KNITTED"**
Senza cuciture, elasticità differenziata, matrice integrata

 **CON ATTACCO**
3.0 MM DI SPESSORE UNIFORME

 **SENZA ATTACCO**
3.0 MM DI SPESSORE UNIFORME

CARATTERISTICHE PRINCIPALI

 1/5 dell' attrito del silicone normale

 Silicone medicale rivestito dal tessuto "knitted"

 Leggera

 Riduce l'effetto di stantuffamento

 Materiale skin friendly e profilo sottile

 Regola la temperatura del moncone

TEST DI FRIZIONE

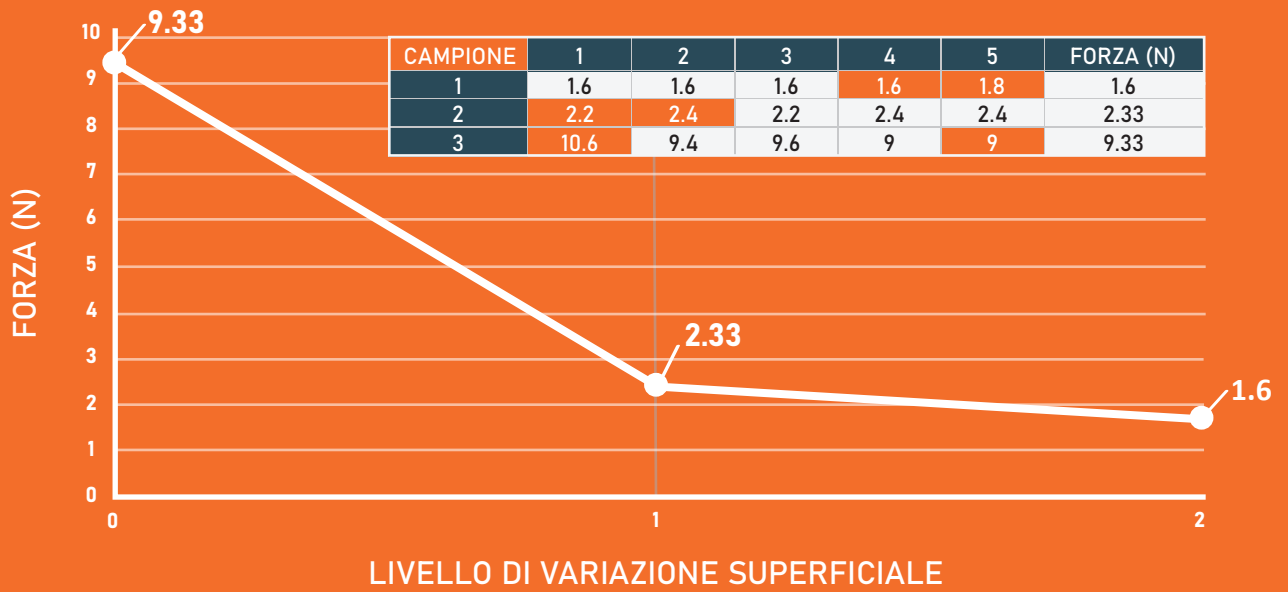

SEZIONE TRASVERSALE

3.0 mm Uniforme

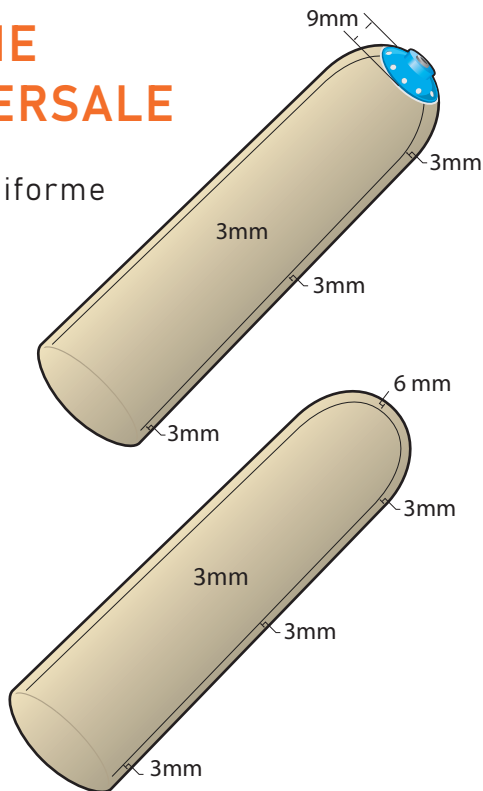

COME SCEGLIERE LA TAGLIA

Misurare la circonferenza a 6 cm dall'apice distale



TABELLA MISURE

CIRCONFERENZA (CM)	CON ATTACCO 3.0 MM UNIFORME	SENZA ATTACCO 3.0 MM UNIFORME
20-22 cm	LSL3.0-20	LSC3.0-20
22-24 cm	LSL3.0-22	LSC3.0-22
24-26 cm	LSL3.0-24	LSC3.0-24
26-28 cm	LSL3.0-26	LSC3.0-26
28-30 cm	LSL3.0-28	LSC3.0-28
30-32 cm	LSL3.0-30	LSC3.0-30
32-35 cm	LSL3.0-32	LSC3.0-32
35-38 cm	LSL3.0-35	LSC3.0-35
38-41 cm	LSL3.0-38	LSC3.0-38
41-44 cm	LSL3.0-41	LSC3.0-41
44-47 cm	LSL3.0-44	LSC3.0-44

FLEX SLEEVE

SFX

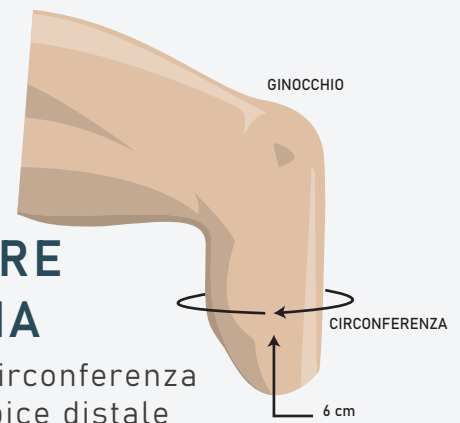
Ginocchiera protesica in gel

DESCRIZIONE

La ginocchiera protesica in gel ALPS™ Flex Sleeve (SFX) combina un tessuto senza cuciture al Gel ad Alta Densità (HD) per offrire il massimo comfort. La ginocchiera SFX ha 30° di pre-flessione; consente di piegare agevolmente il ginocchio e riduce l'ingombro nel cavo popliteo.

CARATTERISTICHE PRINCIPALI



30° di
pre-flessione



Il Gel ad Alta Densità (HD)
assicura un ottimo
controllo anche ai pazienti
attivi



Una sola lunghezza si adatta
alla maggior parte degli
utilizzatori

**TESSUTO "KNITTED"
SENZA CUCITURE**

Prodotto da ALPS con
filati di alta qualità

DISPONIBILE IN 2 COLORI



TESSUTO NERO



TESSUTO BEIGE

SEZIONE TRASVERSALE



3 MM UNIFORME



3 MM UNIFORME

COME SCEGLIERE LA TAGLIA
 Misurare la circonferenza 10 cm sopra la rotula



CIRCONFERENZA
 10 cm
 GINOCCHIO

TABELLA MISURE

CIRCONFERENZA (CM)	3.0 MM UNIFORME TESSUTO BEIGE	3.0 MM UNIFORME TESSUTO NERO
34-37 cm	SFX20 - 3B	SFX20 - 3G
36-39 cm	SFX23 - 3B	SFX23 - 3G
38-42 cm	SFX26 - 3B	SFX26 - 3G
41-46 cm	SFX29 - 3B	SFX29 - 3G
45-50 cm	SFX32 - 3B	SFX32 - 3G

EasySleeve

SFR

La ginocchiera protesica ALPS® EasySleeve fornisce tutto il comfort dell'EasyGel. L'elasticità del tessuto assicura al paziente una grande libertà nella flessione del ginocchio. L'EasySleeve aderisce alla pelle per garantire una sospensione sicura, senza costringere la circolazione. Il basso coefficiente di attrito dell'EasyGel allevia la pelle dalle sollecitazioni create dalle forze di taglio.



Materiale



EasyGel

Tessuto



Tessuto
Beige

Livello di attività



K1 ✓



K2 ✓



K3



K4

Spessore



3 mm

6 mm

Benefici



Facile da indossare anche per pazienti con ridotta coordinazione delle mani



Adatta a pelli delicate e fragili grazie all'agente antiossidante contenuto nel gel



Minimizza la compressione e le irritazioni a livello prossimale



Assicura grande libertà nella flessione del ginocchio



Allevia la pelle dalle sollecitazioni create dalle forze di taglio grazie al basso coefficiente di attrito dell'EasyGel

EasySleeve SFR. Tabella misure.

Misurare la circonferenza della coscia 10 cm al di sopra della rotula.

Circonferenza misurata (cm)	3mm o 6mm uniforme
16-19 cm	SFR10-(3 o 6)
20-24 cm	SFR16-(3 o 6)
25-30 cm	SFR20-(3 o 6)
31-34 cm	SFR24-(3 o 6)
35-37 cm	SFR26-(3 o 6)
38-40 cm	SFR28-(3 o 6)
41-45 cm	SFR32-(3 o 6)
46-60 cm	SFR38-(3 o 6)
61-70 cm	SFR44-(3 o 6)

Sezione trasversale

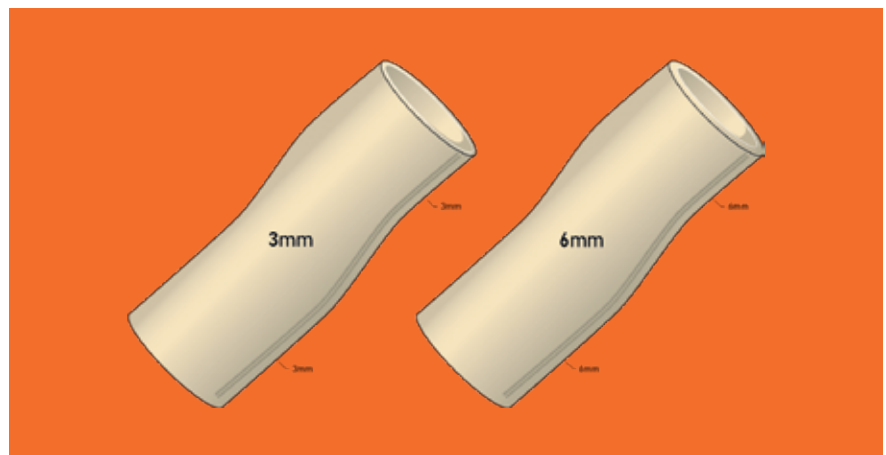

COMPENSATORI DI VOLUME

KCN | KCM | KCW



I compensatori di volume ALPS® sono leggeri e morbidi, ammortizzano e forniscono comfort ed una migliore vestibilità.

SPECIFICHE DEL PRODOTTO

STRETTO, MEDIO, LARGO

1, 3, e 5 PLY

EXTRA CORTO, CORTO,
REGOLARE, LUNGO

TRE MODELLI





TRE TAGLIE

TRE SPESSORI

QUATTRO LUNGHEZZE



CARATTERISTICHE PRINCIPALI

-  Aiutano a gestire le variazioni di volume
-  Il tessuto tecnico consente una vestibilità fresca e confortevole
-  Mantengono la forma nel tempo con un allungamento minimo e non infeltriscono
-  **ORA DISPONIBILI IN SET!**
Una soluzione completa per i pazienti per gestire la variazione di volume del loro arto residuo. Gli spessori più comuni sono sempre a portata di mano.



REALIZZATI CON FIBRE TECNICHE PREMIUM

CREANO UN SISTEMA DI GESTIONE DELL'UMIDITÀ ALLONTANANDO IL SUDORE DAL CORPO E ATTRAVERSO IL TESSUTO, DOVE PUÒ EVAPORARE RAPIDAMENTE.

CON I SET IL TUO PAZIENTE PUÒ:

- Selezionare i compensatori necessari per gestire la sua variazione di volume
- Avere compensatori sempre disponibili mentre si lavano quelli utilizzati in precedenza

SCHEMA DELLA VESTIBILITÀ

E' consigliabile che il calzino sia circa 5cm più lungo dell'invaso.

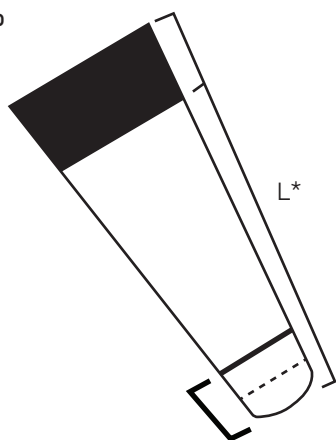

Circonferenza distale a 5 cm

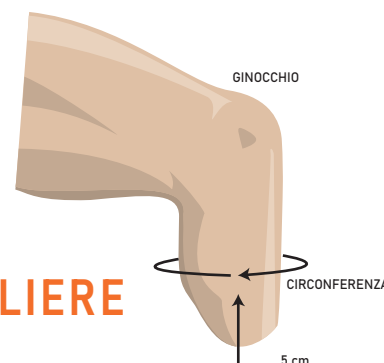

COME SCEGLIERE LA TAGLIA

Misurare la circonferenza a 5 cm dall'apice distale

TABELLA MISURE

TROVA LA VESTIBILITÀ PERFETTA.

MISURA DELLA CUFFIA ALPS CONSIGLIATA	LIVELLO DI AMPUTAZIONE	CIRCONFERENZA PROSSIMALE	CIRCONFERENZA DISTALE A (5 CM)	*LUNGHEZZA DELL'INVASO 13-18 CM	*LUNGHEZZA DELL'INVASO 18-23 CM	*LUNGHEZZA DELL'INVASO 23-38 CM	*LUNGHEZZA DELL'INVASO 38-48 CM
20	BK	min. 20-max. 40 cm	20-23 cm	KCN-8-X-Y	KCN-10-X-Y	KCN-14-X-Y	KCN-18-X-Y
24, 26, 28	BK	min. 30-max. 60 cm	23-31 cm	KCM-8-X-Y	KCM-10-X-Y	KCM-14-X-Y	KCM-18-X-Y
32, 38	AK	min. 40-max. 80 cm	31-36 cm	KCW-8-X-Y	KCW-10-X-Y	KCW-14-X-Y	KCW-18-X-Y

X indica lo spessore in ply (1Ply= 1,5mm; 3Ply= 2mm; 5Ply=2,5mm)

Y indica l'opzione distale (N-senza foro; H con foro; HR con foro rinforzato)

ESEMPI:

KCN-08-3-H Compensatore di volume, Stretto, Extra Corto, 3 Ply, con foro

KCM-10-1-N Compensatore di volume, Medio, Corto, 1 Ply, senza foro

KCW-18-5-HR Compensatore di volume, Largo, Lungo, 5 Ply, con foro rinforzato

VACUUM INTEGRATED PUMP

VIP







DESCRIZIONE

IL VIP è un generatore di vuoto pneumatico per protesi.

L'uso del VIP fornisce ai pazienti un contatto totale costante quando indossano la protesi. Ciò è fondamentale per la ripartizione uniforme del peso e per distribuire la sospensione della protesi sull'intera superficie del moncone.

Il vuoto creato dal VIP stabilizza il moncone, risolvendo qualsiasi problema connesso alla variazione di volume dell'arto residuo nell'arco della giornata.

ULTERIORI BENEFICI

-  Gestisce in modo efficiente le fluttuazioni di volume del moncone, offrendo così un migliore controllo e comfort della protesi
-  Riduce l'intensità dei picchi di pressione sull'arto residuo, migliorando il comfort e fornendo maggiore libertà di movimento
-  Aiuta a preservare la salute della pelle migliorando la circolazione e aumentando di conseguenza l'ossigenazione dell'arto
-  Non compromette l'estetica della protesi

Facile da
installare

Migliora la
circolazione
sanguigna

Migliora
il comfort

Migliora la
camminata

Silenzioso

Leggero

DISPONIBILE IN DUE DIVERSI LIVELLI DI VUOTO ATTIVO

**ALTO VUOTO ATTIVO
(Rosso)**
10-13 inHg

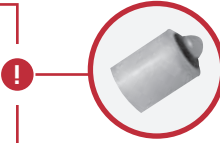

Si consiglia di utilizzare la **mini valvola** per prevenire il dislocamento del VIP dalla sede

**BASSO VUOTO ATTIVO
(Verde)**
5-8 inHg



SCEGLIERE IL LIVELLO DI VUOTO IN BASE A:



LIVELLO DI ATTIVITA'



CONDIZIONI DELLA PELLE

SENZA PIASTRA DI MONTAGGIO



CON PIASTRA DI MONTAGGIO



SPECIFICHE DEL PRODOTTO

	ALTO VUOTO ATTIVO (ROSSO)	BASSO VUOTO ATTIVO (VERDE)
CODICE ARTICOLO	VIP - DH	VIP - DL
DIAMETRO	66MM	66MM
ALTEZZA	48MM	48MM
PESO	75G	64G
MATERIALE	SILICONE	SILICONE

PER EFFETTUARE L'ORDINE UTILIZZARE I CODICI SOTTOSTANTI

NOME PRODOTTO	CODICE PRODOTTO
DIMA	VE319 - D
DIMA CORTA	VE319 - SD
PIASTRA DI MONTAGGIO	VE819 - P
LOCK (PICCOLO)	VIP-L1120-S
MINI VALVOLA (Vivamente raccomandata)	MV-009
KIT MINI VALVOLA	LMV-009
PIN (4.8cm)	VIP-92L
PIN (3.0cm)	VIP-92S





www.orthoservice.com



UNI EN ISO 13485:2016
UNI EN ISO 9001:2015



Organismo accreditato da ACCREDIA
Body registered by ACCREDIA



ORTHOSERVICE AG

Via Milano, 7
CH-6830 Chiasso (TI)
Switzerland

Tel. +41 (0) 91 822 00 88
fax +41 (0) 91 822 00 89
info@orthoservice.com
www.orthoservice.com



9DCCT00053DECHI.0123



ALPS South LLC

2895 42nd Ave. N. · St. Petersburg, FL. 33714, USA
Tel.: 1-727-528-8566 · Fax: 1-727-528-8862
Info@easyliner.com · www.easyliner.com

Distributed by ORTHOSERVICE AG

Via Milano 7 · CH-6830 Chiasso (TI) · Switzerland
Tel. 0041 (0) 91 822 00 88 · Fax 0041 (0) 91 822 00 89
info@orthoservice.com · www.orthoservice.com

Niederlassung Deutschland: Orthoservice Deutschland GmbH

Flugstraße 8 · D-76532 Baden-Baden · Deutschland
Tel. 0049 (0) 7221 991 39 11 · Fax 0049 (0) 7221 991 39 13
info@orthoservice.de · www.orthoservice.de

Siedziba w Polsce: ORTHOSERVICE POLSKA Sp. z o.o.

ul. Warszawska 416a · 42-209 Częstochowa Polska
Tel.: +48 (0) 34 340 13 10
www.orthoservice.pl · info@orthoservice.pl

Sede italiana: RO+TEN S.r.l.

Sede legale: Via Marco De Marchi, 7 · I-20121 Milano (MI) · Italia

Sede operativa e amministrativa:

Via Comasina, 111 · I-20843 Verano Brianza (MB) · Italia
Tel. 0039 039 601 40 94 · Fax 0039 039 601 42 34
info@roplusten.com · www.roplusten.com

Società soggetta a Direzione e Coordinamento
(art. 2497bis CC): **Orthoservice AG** (CH) 6830 Chiasso (TI) · Switzerland

Copyright Orthoservice Ro+Ten 2022



ORTHOSERVICE RO+TEN

Take care feel better